

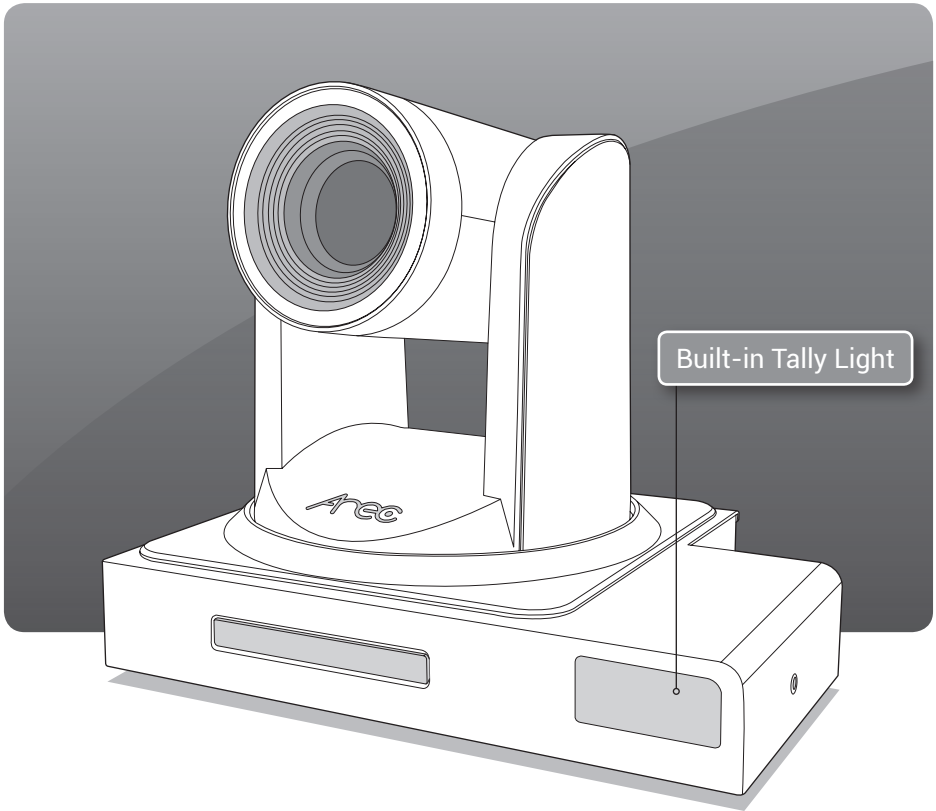

CI-22H

Full HD PTZ Conference Camera 20X

User Manual | English



Preface

This manual introduces the function installation and operation of the Camera.
Prior to installation and usage, please read the manual thoroughly.

1. Warning

- (1) This product can be only used in specified range in order to avoid any damage or danger;
- (2) Don't expose the camera to rain or moisture place
- (3) Don't remove the cover to reduce the risk of electric shock. Refer servicing to qualified personnel.
- (4) Never operate the camera under unqualified temperature , humidity and power supply;
- (5) Please use the soft cloth to clean the camera. Use neuter cleanser if bad smeared .Don't use the strong or cleanser avoiding scuffing.

2. Electric Safety

Installation and operation must accord with electric safety standard.

3. Caution to transport

Avoid stress,vibration and soakage in transport,storage and installation.

4. Polarity of power supply

This product uses DC 12V power supply.

5. Careful of installation

- (1) This series item must put on the smooth desk or platform,and it can not be installed slant ways.
- (2) Don't apply in corrosive liquid,gas or solid environment to avoid the cover which is made up of organic material.
- (3) This product has a heating device inside, please keep ventilated.
- (4) Never power on before installation is completed.

6. Don't disassemble discretionarily

We are not responsible for any unauthorized modification or dismantling.

7. Attention

Electromagnetic filed under certain rate may affect camera image!

Table of Contents

Preface	02
Product overview	05
Quick Installation Instructions	09
Connection	11
Chapter 1 Applications	12
1.1 RS-232 Interface	12
1.1.1 RS-232C interface specification as shown below	12
1.1.2 RS-232 Mini-DIN 8-pin Port Definition	12
1.1.3 RS232 (DB9) Port Definition	13
1.1.4 VISCA networking as shown below	13
1.2 Serial Communication Control	14
1.2.1 VISCA protocol list	14
1.2.2 Pelco-D protocol command list	20
1.2.3 Pelco-P protocol command list	21
Chapter 2. Remote Controller	22
2.1 Keys Instruction	22
2.2 Menu Setting	24
2.2.1 Main Menu	24
2.2.2 System Setting	24
2.2.3 Camera Setting	24
2.2.4 P/T/Z	27
2.2.5 Video Format	27
2.2.6 Version	27
2.2.7 Restore Default	28
Chapter 3. Network Connection	29
3.1 Direct connection	29
3.2 Internet connection mode	31
Chapter 4. Overview of the Web Interface	32
4.1 Preview	33
4.2 Playback	34
4.3 Configuration	35
4.3.1 Local configure	36
4.3.2 Video configure	37
4.3.2.1 Video encode	38
4.3.2.2 Stream publish	39
4.3.2.3 Video parameters	40
4.3.2.4 Video OSD	44
4.3.2.5 OSD font size	45
4.3.2.6 Video out	45
4.3.3 Network Configure	46
4.3.3.1 Network port	47
4.3.3.2 Ethernet parameters	48
4.3.3.3 DNS	49
4.3.3.4 GB28181	50
4.3.4 System configure	51

Table of Contents

4.3.4.1 System attribute	52
4.3.4.2 System time	53
4.3.4.3 User set	55
4.3.4.4 Release upgrade	56
4.3.4.5 Restore factory defaults	56
4.3.4.6 Reboot	56
4.4 Logout	56
Chapter 5. Camera Maintenance and Troubleshooting	57
5.1 Camera Maintenance	57
5.2 Troubleshooting	57

Product Overview

CI-22H Auto-Tracking PTZ Camera is a professional-grade high quality PTZ camera that also can track a moving presenter automatically while shooting video. Combining a high-performance pan/tilt/zoom camera, compact design and excellent motion-sensitive tracking technology, CI-22H is ideal for mid to large-size conference, huddle rooms, or lecture capture, bridging the feature and price gap between current webcam and professional PTZ cameras in the market.

1. Dimension

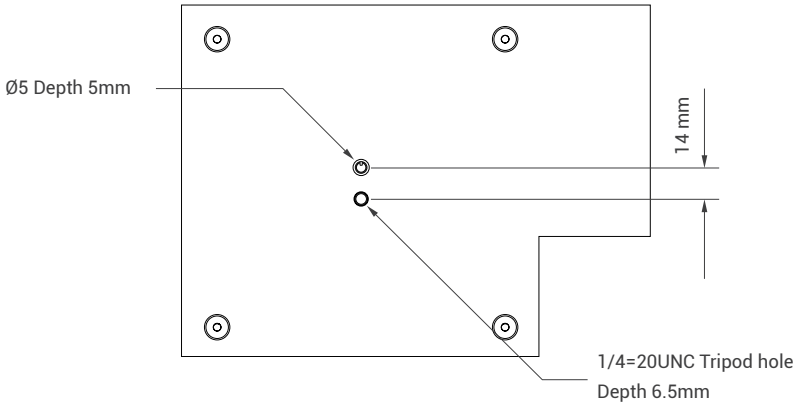
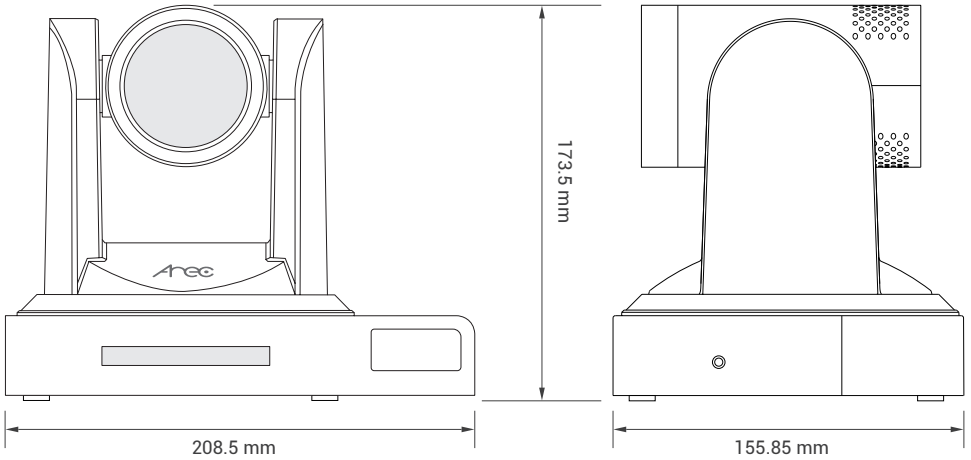

2. Accessory

No.	CI-22H
1	Power Adaptor
2	RS-232 Cable
3	USB2.0 Cable
4	USB3.0 Cable
5	Remote Controller
6	X type 2 in 1 Cable (RS-232 & Power)
7	Quick Installation Guide

3. Camera performance

The camera offers perfect functions, superior performance and versatile interfaces. The features include advanced ISP processing algorithms to provide vivid images with a strong sense of depth, high resolution and fantastic color rendition. It supports H.264/H.265 encoding which makes motion video fluent and clear even with less than ideal bandwidth conditions. By adopting high accuracy step driving motor mechanism, it works extremely quiet and moves smoothly and very quickly to designated position. Product works stable and reliable, and it is easy to use, installation and maintenance.

4. Technical specification

Camera Parameter	
Optical Zoom	20X, f = 5.2 ~ 98mm
Sensor	1/2.8 inch high quality full HD CMOS sensor
Effective Pixels	16:9 2.07 megapixel
Video Format	<p>HDMI video format 1080P60/50/30/25/59.94/29.97;1080I60/50/59.94; 720P60/50/30/25/59.94/29.97</p> <p>U3 video format (1) U3: 1920X1080P60/50/30/25;1280X720P60/50/30/25;960X540P30; 640X360P30;640X480P30;352X288P30;960X540P30; (2) U3 compatible with U2: 960X540P30; 640X360P30; 1280X720P10/15; 720X576P50; 720X480P60; 640X480P30; 352X288P30.</p> <p>U2 video format 176x144/320x240/320x180/352x288/640x480/720x576/640x360/ 800x600/960x540/1024x576/1024x768/1600x896/1920x1080/1280x720; P30/25/20/15/10/5</p>
View Angle	3.2°(tele)--55.8°(wide)
Iris	F1.5--F3.0
Digital Zoom	10X
Minimum Illumination	0.5Lux (F1.8,AGC ON)
DNR	2D & 3D DNR
White Balance	Auto / Manual / One Push / 3000K / 3500K / 4000K / 4500K / 5000K / 5500K / 6000K / 6500K / 7000K
Exposure	Auto / Manual / Shutter Automatic Exposure / Aperture Automatic Exposure / Brightness priority
Focus	Auto / Manual / One Push
Aperture	Auto / Manual
Electronic Shutter	Auto / Manual
BLC	ON / OFF
WDR	OFF / Dynamic level adjustment
Video Adjustment	Brightness, Color, Saturation, Contrast, Sharpness, B/W mode, Gamma curve
SNR	>55dB
Input/ Output Interface	
Video Interfaces	RS232(INPUT), LAN, HDMI, USB3.0, USB2.0

Built-in Tally Light	Yes
Image Code Stream	Dual stream output
Image Output Multiple Code Source	Dual Code Source output (HDMI/USB3.0, LAN)
Video Compression Format	H.264, H.265
Audio Output	HDMI/LAN output together with video
Audio Compression Format	AAC, MP3, G.711A
HD IP Interface	100M IP port (100BASE-TX)
Network Protocol	RTSP/RTMP, ONVIF, GBT28181; Support IP Visca control protocol; Distance update, Distance restart, Distance reset
Control Interface	RS232
Control Protocol	VISCA/Pelco-D/Pelco-P; Baud Rate: 115200/9600/4800/2400 bps
Power Interface	HEC3800 outlet (DC12V)
Supply Adapter	AC110V-AC220V to DC12V/2A
Input Voltage	DC12V±10%
Input Current	2A (Max)
Power Consumption	24W (Max)

PTZ Parameter

Pan Rotation	±170°
Tilt Rotation	-30°~+90°
Pan Control Speed	0.1-60°/sec
Tilt Control Speed	0.1-30°/sec
Preset Speed	Pan: 60°/sec, Tilt: 30°/sec
Preset Number	Preset Number 255 presets (10 presets by remote controller)

Other Parameter

Store Temperature	-10°C ~ +60°C
Store Humidity	20% - 95%
Working Temperature	-10°C ~ +50°C
Working Humidity	20% - 80%
Dimension (L x W x H)	208.5 x 155.85 x 173.5 mm
Weight	1.54 kg
Using Environment	Indoor

Quick Installation Instructions

1. Camera interface and indicators description

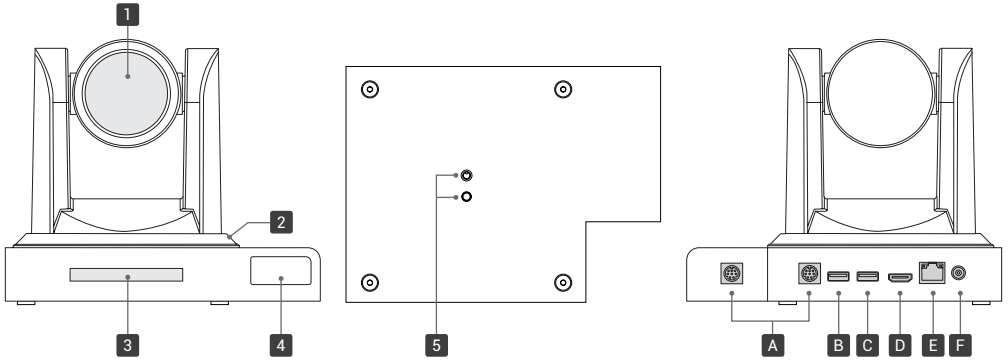

No.	CI-22H
1	Camera Lens
2	Base
3	IR receiver sensor
4	Tally light
5	Standard 1/4"20 UNC screw
A	RS232 Control Interface (Input)
B	USB2.0 interface
C	USB3.0 interface
D	HDMI interface
E	LAN interface
F	DC12V Input Power Supply Socket

No.	LED Color	Glow Rule	Operation
3	Red/ Green dual-color light	Red light blinking	Power Adaptor plug to Socket
		Green light turns on	Power on
		Green light blinking	Receive remote control signal
4	Red light	Red light turns on	Recording

1.1 Power on initial configuration

- (1) Power on: Connect DC12V power supply adapter with power supply socket.
- (2) Initial configuration: Power on with power indicator light on and remote control receiver light blinking, camera head moves from bottom left to the bottom, and then goes to the HOME position (intermediate position of both horizontal and vertical), while the camera module stretches. When remote control receiver light stops blinking, the self-checking is finished.

Note:

1. The default address of the remote controller is the 1# address.
2. If you set preset 0, when Power on self-test is completed, the camera automatically moves to the preset 0 position.

1.2 Video output

(1) Video Output from LAN

- a. Network Cable Connection Port: Connect this product and your computer through network cable, the device LAN interface refer to item E in Figure 1.1.
- b. Webpage Login: Open your browser and enter 192.168.11.202 in the address bar (factory default); press Enter to enter into the login page; click on the "player is not installed, please download and install!" and follow the installation steps for installation. Then enter the user name admin and password admin (factory default); press Enter to enter into the preview page, users can carry out PTZ control, video recording, playback, configuration and other operations.
(NOTE: If you forget your user name, password, IP address, you can manually restore the default by the remote controller key combination * #)

(2) HDMI Video Output

- a. HDMI Video Cable Connection: CI-22H refer to item D in Figure 1.1
- b. Connect the camera and the monitor via HDMI video cable; video output is available after camera self-test.

(3) USB3.0 video output

- a. USB3.0 video cable connection: CI-22H refer to item C in Figure 1.1
- b. Connect the camera and the monitor via USB3.0 video cable, open video player software, select video device, and then video output will be available.

(4) USB3.0 compatible USB2.0 video output

- a. USB3.0 video cable connection: CI-22H refer to item C in Figure 1.1
- b. Connect the camera and the monitor via USB3.0 video cable, open video player software, select video device, and then video output will be available.

(5) USB2.0 video output

- a. USB2.0 video cable connection: CI-22H refer to item B in Figure 1.1
- b. Connect the camera and the monitor via USB2.0 video cable, open video player software, select video device, and then video output will be available.

Connection

Step 1 Connection

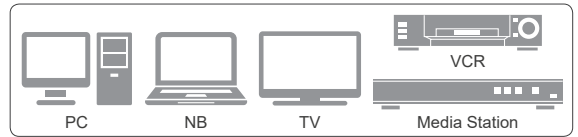
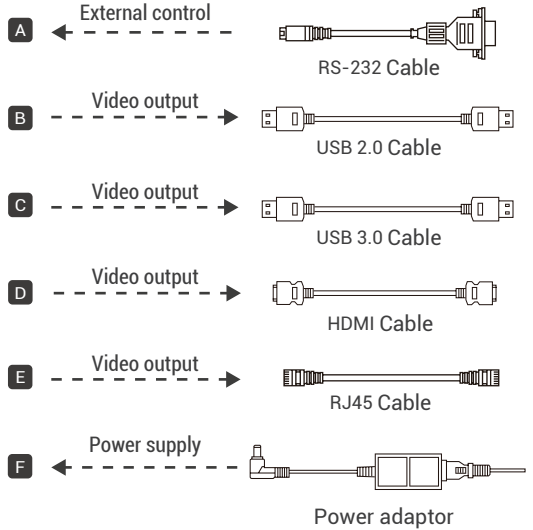
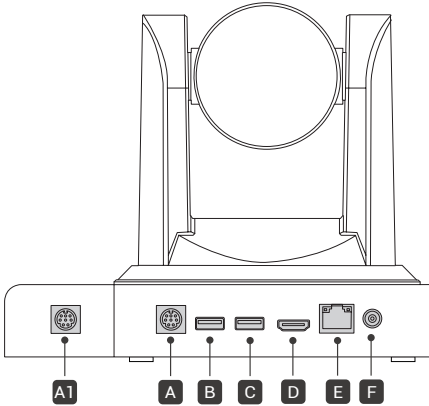

Step 2 Setup X type 2 in 1 cable

Use the X type 2 in 1 cable connected to Tally Light, refer Camera Interface Instruction

- a. Connect A1, A, F in sequence
- b. Finally, connect the camera power adaptor to G

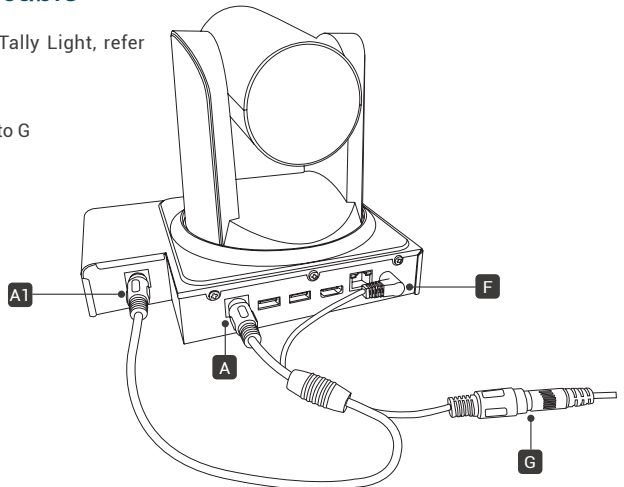

Chapter 1. Applications

1.1 RS-232 Interface

1.1.1 RS-232C interface specification as shown below

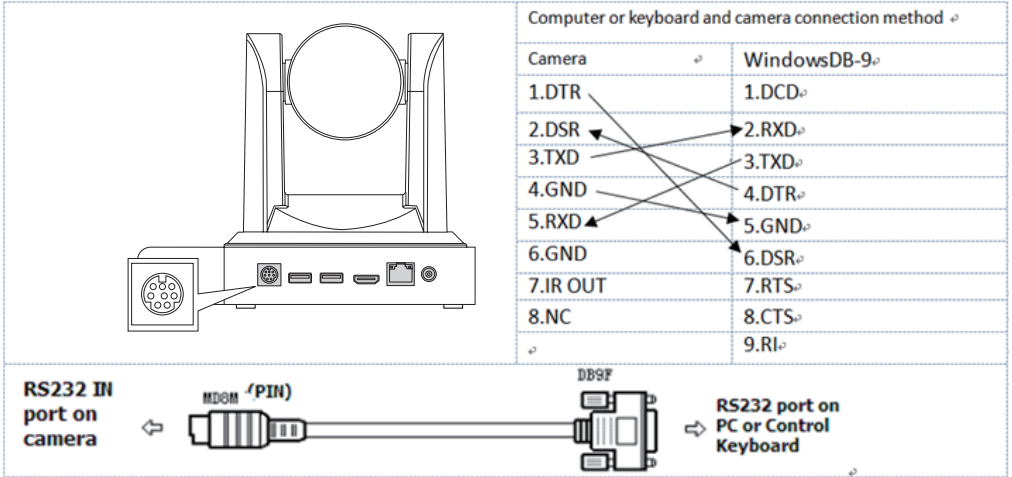

1.1.2 RS-232 Mini-DIN 8-pin Port Definition

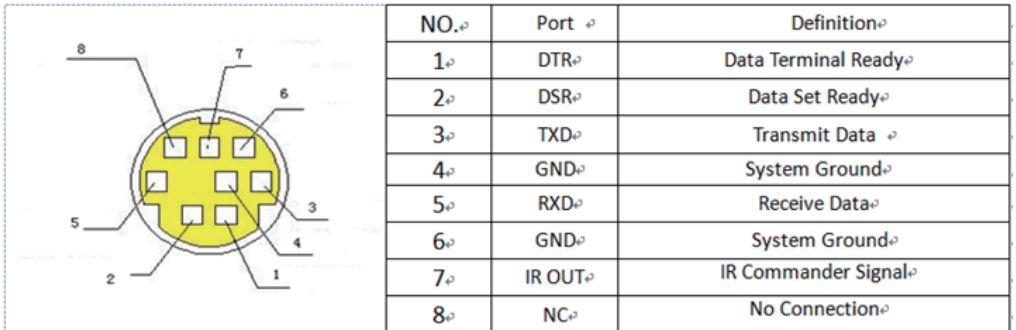

1.1.3 RS232 (DB9) Port Definition

NO.	Port	Definition
1	DCD	Data Carrier Detect
2	RXD	Receive Data
3	TXD	Transmit Data
4	DTR	Data Terminal Ready
5	GND	System Ground
6	DSR	Data Set Ready
7	RTS	Request to Send
8	CTS	Clear to Send
9	RI	Ring Indicator

1.1.4 VISCA networking as shown below

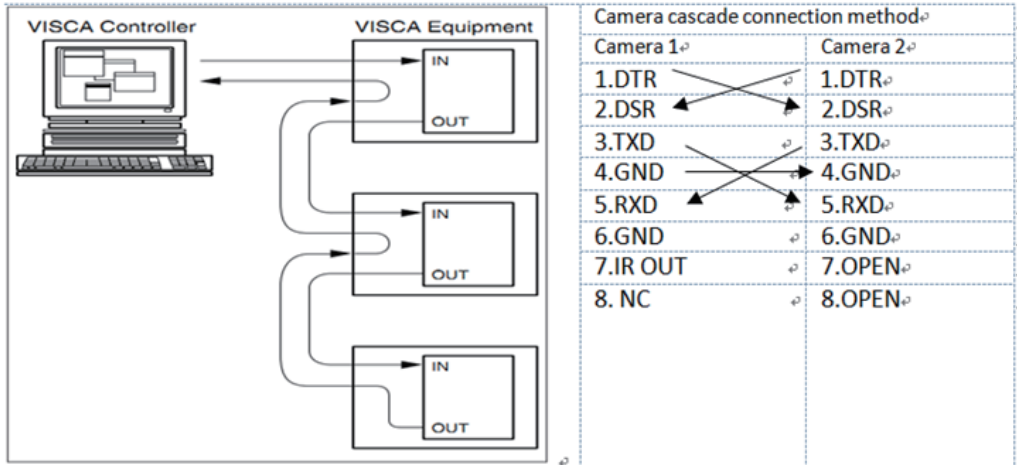

1.2 Serial Communication Control

Under common working condition, the camera could be controlled through RS232/RS485 interface (VISCA), RS232C serial parameter are as follows:

Baud rate: 2400/4800/9600/115200 bits / sec; Start bit: 1; data bits: 8; Stop bit: 1; Parity: None.

After power on, the camera first go left, then back to the middle position. Self-test is finished after the zoom moved to the farthest and then back to the nearest position. If the camera saved 0 preset before, it will be back to that position after initialization. At this point, the user can control the camera by the serial commands.

1.2.1 VISCA protocol list

(1) Camera return command

Ack/Completion Message		
	Command packet	Note
ACK	z0 41 FF	Returned when the command is accepted.
Completion	z0 51 FF	Returned when the command has been executed.

z = camera address + 8

Error Messages		
	Command packet	Note
Syntax Error	z0 60 02 FF	Returned when the command format is different or when a command with illegal command parameters is accepted
Command Not Executable	z0 61 41 FF	Returned when a command cannot be executed due to current conditions. For example, when commands controlling the focus manually are received during auto focus.

(2) Camera control command

Command	Function	Command packet	Note
AddressSet	Broadcast	88 30 0p FF	p: Address setting
IF_Clear	Broadcast	88 01 00 01 FF	I/F Clear
CommandCancel		8x 21 FF	
CAM_Power	On	8x 01 04 00 02 FF	Power ON/OFF
	Off	8x 01 04 00 03 FF	
CAM_Zoom	Stop	8x 01 04 07 00 FF	p = 0(low) - F(high) pqrs: Zoom Position
	Tele(Standard)	8x 01 04 07 02 FF	
	Wide(Standard)	8x 01 04 07 03 FF	
	Tele(Variable)	8x 01 04 07 2p FF	
	Wide(Variable)	8x 01 04 07 3p FF	
	Direct	8x 01 04 47 0p 0q 0r 0s FF	

CAM_Focus	Stop	8x 01 04 08 00 FF	
	Far(Standard)	8x 01 04 08 02 FF	
	Near(Standard)	8x 01 04 08 03 FF	
	Far(Variable)	8x 01 04 08 2p FF	p = 0(low) - F(high)
	Near (Variable)	8x 01 04 08 3p FF	
	Direct	8x 01 04 48 0p 0q 0r 0s FF	pqrs: Focus Position
	Auto Focus	8x 01 04 38 02 FF	
	Manual Focus	8x 01 04 38 03 FF	
CAM_Zoom Focus	Direct	8x 01 04 47 0p 0q 0r 0s 0t 0u 0v 0w FF	pqrs: Zoom Position tuvw: Focus Position
CAM_WB CAM_RGain	Auto	8x 01 04 35 00 FF	
	3000K	8x 01 04 35 01 FF	
	4000k	8x 01 04 35 02 FF	
	One Push mode	8x 01 04 35 03 FF	
	5000k	8x 01 04 35 04 FF	
	Manual	8x 01 04 35 05 FF	
	6500k	8x 01 04 35 06 FF	
	Reset	8x 01 04 03 00 FF	
	Up	8x 01 04 03 02 FF	Manual Control of R Gain
	Down	8x 01 04 03 03 FF	
	Direct	8x 01 04 43 00 00 0p 0q FF	pq: R Gain
CAM_Bgain	Reset	8x 01 04 04 00 FF	
	Up	8x 01 04 04 02 FF	Manual Control of B Gain
	Down	8x 01 04 04 03 FF	
	Direct	8x 01 04 44 00 00 0p 0q FF	pq: B Gain
CAM_AE	Full Auto	8x 01 04 39 00 FF	Automatic Exposure mode
	Manual	8x 01 04 39 03 FF	Manual Control mode
	Shutter priority	8x 01 04 39 0A FF	Shutter Priority Automatic Exposure mode
	Iris priority	8x 01 04 39 0B FF	Iris Priority Automatic Exposure mode
	Bright	8x 01 04 39 0D FF	Bright mode
CAM_Shutter	Reset	8x 01 04 0A 00 FF	
	Up	8x 01 04 0A 02 FF	Shutter Setting
	Down	8x 01 04 0A 03 FF	
	Direct	8x 01 04 4A 00 00 0p 0q FF	pq: Shutter Position
CAM_Iris	Reset	8x 01 04 0B 00 FF	
	Up	8x 01 04 0B 02 FF	Iris Setting
	Down	8x 01 04 0B 03 FF	
	Direct	8x 01 04 4B 00 00 0p 0q FF	pq: Iris Position
CAM_Gain Limit	Gain Limit	8x 01 04 2C 0p FF	p: Gain Positon

CAM_Bright	Reset	8x 01 04 0D 00 FF	Bright Setting
	Up	8x 01 04 0D 02 FF	
	Down	8x 01 04 0D 03 FF	
	Direct	8x 01 04 4D 00 00 0p 0q FF	pq: Bright Positon
CAM_ExpComp	On	8x 01 04 3E 02 FF	Exposure Compensation ON/OFF
	Off	8x 01 04 3E 03 FF	
	Reset	8x 01 04 0E 00 FF	Exposure Compensation Amount Setting
	Up	8x 01 04 0E 02 FF	
	Down	8x 01 04 0E 03 FF	
	Direct	8x 01 04 4E 00 00 0p 0q FF	
CAM_Back Light CAM_WDRStrength CAM_NR(2D)	On	8x 01 04 33 02 FF	Back Light Compensation WDR Level Setting p : WDR Level Positon
	Off	8x 01 04 33 03 FF	
	Reset	8x 01 04 21 00 FF	
	Up	8x 01 04 21 02 FF	
	Down	8x 01 04 21 03 FF	
	Direct	8x 01 04 51 00 00 00 0p FF	
		8x 01 04 53 0p FF	P=0-7 0: OFF
CAM_NR(3D)		8x 01 04 54 0p FF	P=0-8 0: OFF
CAM_Gamma		8x 01 04 5B 0p FF	p = 0 - 4 0: Default 1: 0.47 2: 0.50 3: 0.52 4: 0.55
CAM_Flicker CAM_Aperture	OFF	8x 01 04 23 00 FF	OFF
	50HZ	8x 01 04 23 01 FF	50HZ
	60HZ	8x 01 04 23 02 FF	60HZ
	Reset	8x 01 04 02 00 FF	Aperture Control
	Up	8x 01 04 02 02 FF	
	Down	8x 01 04 02 03 FF	
Direct	8x 01 04 42 00 00 0p 0q FF	pq: Aperture Gain	
CAM_Memory	Reset	8x 01 04 3F 00 pq FF	pq: Memory Number(=0 to 254)
	Set	8x 01 04 3F 01 pq FF	Corresponds to 0 to 9 on the Remote Commander
	Recall	8x 01 04 3F 02 pq FF	
CAM_LR_Reverse	On	8x 01 04 61 02 FF	Image Flip Horizontal ON/OFF
	Off	8x 01 04 61 03 FF	
CAM_PictureFlip	On	8x 01 04 66 02 FF	Image Flip Vertical ON/OFF
	Off	8x 01 04 66 03 FF	
CAM_ColorSaturation	Direct	8x 01 04 49 00 00 00 0p FF	P=0-7 0:60% 1: 70% 2: 80% 3: 90% 4: 100% 5: 110% 6: 120% 7: 130%
CAM_IDWrite		8x 01 04 22 0p 0q 0r 0s FF	pqrs: Camera ID (=0000 to FFFF)

SYS_Menu IR_Receive IR_ReceiveReturn CAM_SettingReset	ON	8x 01 04 06 06 02 FF	Turn on the menu screen
	OFF	8x 01 04 06 06 03 FF	Turn off the menu screen
	ON	8x 01 06 08 02 FF	IR(remote commander)receive On/Off IR(remote commander)receive message via the VISCA communication ON/OFF Reset Factory Setting
	OFF	8x 01 06 08 03 FF	
	On	8x 01 7D 01 03 00 00 FF	
	Off	8x 01 7D 01 13 00 00 FF	
Reset	8x 01 04 A0 10 FF		
CAM_Brightness	Direct	8x 01 04 A1 00 00 0p 0q FF	pq: Brightness Position
CAM_Contrast	Direct	8x 01 04 A2 00 00 0p 0q FF	pq: Contrast Position
CAM_Flip CAM_VideoSystem	OFF	8x 01 04 A4 00 FF	Single Command For Video Flip
	Flip-H	8x 01 04 A4 01 FF	P : 0~E Video format
	Flip-V	8x 01 04 A4 02 FF	0: 1080P60 8: 720P30
	Flip-HV	8x 01 04 A4 03 FF	1: 1080P50 9: 720P25
	Set camera video system	8x 01 06 35 00 0p FF	2: 1080i60 A: 1080P59.94 3: 1080i50 B: 1080i59.94 4: 720P60 C: 720P59.94 5: 720P50 D: 1080P29.97 6: 1080P30 E: 720P29.97 7: 1080P25
Pan_tiltDrive	Up	8x 01 06 01 VV WW 03 01 FF	VV : Pan speed 0x01 (low speed) to 0x18 (high speed) WW : Tilt speed 0x01 (low speed) to 0x14 (high speed) YYYY : Pan Position ZZZZ : Tilt Position
	Down	8x 01 06 01 VV WW 03 02 FF	
	Left	8x 01 06 01 VV WW 01 03 FF	
	Right	8x 01 06 01 VV WW 02 03 FF	
	Upleft	8x 01 06 01 VV WW 01 01 FF	
	Upright	8x 01 06 01 VV WW 02 01 FF	
	DownLeft	8x 01 06 01 VV WW 01 02 FF	
	DownRight	8x 01 06 01 VV WW 02 02 FF	
	Stop	8x 01 06 01 VV WW 03 03 FF	
	AbsolutePosition	8x 01 06 02 VV WW 0Y 0Y 0Y 0Y 0Z 0Z 0Z 0Z FF	
	RelativePosition	8x 01 06 03 VV WW 0Y 0Y 0Y 0Y 0Z 0Z 0Z 0Z FF	
	Home	8x 01 06 04 FF	
Reset	8x 01 06 05 FF		
Pan-tiltLimitSet	Set	8x 01 06 07 00 0W 0Y 0Y 0Y 0Y 0Z 0Z 0Z 0Z FF	W:1 UpRight 0:DownLeft YYYY : Pan Limit Position(TBD)
	Clear	8x 01 06 07 01 0W 07 0F 0F 0F 07 0F 0F 0F FF	ZZZZ : Tilt Limit Position(TBD)

(3) Inquiry command

Command	Function	Command packet	Note
CAM_PowerInq	8x 09 04 00 FF	y0 50 02 FF	On
		y0 50 03 FF	Off(Standby)
CAM_ZoomPosInq	8x 09 04 47 FF	y0 50 0p 0q 0r 0s FF	pqrs: Zoom Position
CAM_FocusAFModelInq	8x 09 04 38 FF	y0 50 02 FF	Auto Focus
		y0 50 03 FF	Manual Focus
CAM_FocusPosInq	8x 09 04 48 FF	y0 50 0p 0q 0r 0s FF	pqrs: Focus Position
CAM_WBModelInq	8x 09 04 35 FF	y0 50 00 FF	Auto
		y0 50 01 FF	3000K
		y0 50 02 FF	4000K
		y0 50 03 FF	One Push Mode
		y0 50 04 FF	5000K
		y0 50 05 FF	Manual
CAM_RGainInq	8x 09 04 43 FF	y0 50 00 00 0p 0q FF	pq: R Gain
		y0 50 00 00 0p 0q FF	pq: B Gain
CAM_AEModelInq	8x 09 04 39 FF	y0 50 00 FF	Full Auto
		y0 50 03 FF	Manual
		y0 50 0A FF	Shutter priority
		y0 50 0B FF	Iris priority
		y0 50 0D FF	Bright
CAM_ShutterPosInq	8x 09 04 4A FF	y0 50 00 00 0p 0q FF	pq: Shutter Position
CAM_IrisPosInq	8x 09 04 4B FF	y0 50 00 00 0p 0q FF	pq: Iris Position
CAM_Gain LimitInq	8x 09 04 2C FF	y0 50 0p FF	p: Gain Positon
CAM_BrightPosilnq	8x 09 04 4D FF	y0 50 00 00 0p 0q FF	pq: Bright Position
CAM_ExpCompModelInq	8x 09 04 3E FF	y0 50 02 FF	On
		y0 50 03 FF	Off
CAM_ExpCompPosInq	8x 09 04 4E FF	y0 50 00 00 0p 0q FF	pq: ExpComp Position
CAM_BacklightModelInq	8x 09 04 33 FF	y0 50 02 FF	On
		y0 50 03 FF	Off
CAM_WDRStrengthInq	8x 09 04 51 FF	y0 50 00 00 00 0p FF	p: WDR Strength
CAM_NRLevel(2D) Inq	8x 09 04 53 FF	y0 50 0p FF	P. 2DNRLlevel
CAM_NRLevel(3D) Inq	8x 09 04 54 FF	y0 50 0p FF	P.3D NRLevel
CAM_FlickerModelInq	8x 09 04 55 FF	y0 50 0p FF	p: Flicker Settings(0: OFF,1: 50Hz,2:60Hz)
CAM_ApertureInq	8x 09 04 42 FF	y0 50 00 00 0p 0q FF	pq: Aperture Gain
CAM_PictureEffectModelInq	8x 09 04 63 FF	y0 50 00 FF	Off
		y0 50 04 FF	B&W
CAM_MemoryInq	8x 09 04 3F FF	y0 50 0p FF	p: Memory number last operated.

SYS_MenuModelInq	8x 09 06 06 FF	y0 50 02 FF	On
		y0 50 03 FF	Off
CAM_LR_ReverseInq	8x 09 04 61 FF	y0 50 02 FF	On
		y0 50 03 FF	Off
CAM_PictureFlipInq	8x 09 04 66 FF	y0 50 02 FF	On
		y0 50 03 FF	Off
CAM_ColorSaturationInq	8x 09 04 49 FF	y0 50 00 00 00 0p FF	p: Color Gain setting 0h (60%) to Eh (130%)
CAM_IDInq	8x 09 04 22 FF	y0 50 0p FF	p: Gamma ID
IR_ReceiveInq	8x 09 06 08 FF	y0 50 02 FF	On
		y0 50 03 FF	Off
IR_ReceiveReturn		y0 07 7D 01 04 00 FF	Power ON/OFF
		y0 07 7D 01 04 07 FF	Zoom tele/wide
		y0 07 7D 01 04 38 FF	AF ON/OFF
		y0 07 7D 01 04 33 FF	Camera_Backlight
		y0 07 7D 01 04 3F FF	Camera_Memery
		y0 07 7D 01 06 01 FF	Pan_titleDriver
CAM_BrightnessInq	8x 09 04 A1 FF	y0 50 00 00 0p 0q FF	pq: Brightness Position
CAM_ContrastInq	8x 09 04 A2 FF	y0 50 00 00 0p 0q FF	pq: Contrast Position
CAM_FlipInq	8x 09 04 A4 FF	y0 50 00 FF	Off
		y0 50 01 FF	Flip-H
		y0 50 02 FF	Flip-V
		y0 50 03 FF	Flip-HV
CAM_GammaInq	8x 09 04 5B FF	y0 50 0p FF	p: Gamma setting
CAM_VersionInq	8x 09 00 02 FF	y0 50 ab cd mn pq rs tu vw FF	ab cd : vender ID (0220) mn pq : model ID ST (0950) U3 (3950) rs tu : ARM Version vw : reserve
VideoSystemInq	8x 09 06 23 FF	y0 50 0p FF	P. 0~E Video format
			0:1080P60 8:720P30
			1:1080P50 9:720P25
			2:1080i60 A:1080P59.94
			3:1080i50 B:1080i59.94
			4:720P60 C:720P59.94
			5:720P50 D:1080P29.97
			6:1080P30 E:720P29.97
7:1080P25			
Pan-tiltMaxSpeedInq	8x 09 06 11 FF	y0 50 ww zz FF	ww: Pan Max Speed zz: Tilt Max Speed
Pan-tiltPosInq	8x 09 06 12 FF	y0 50 0w 0w 0w 0w 0z 0z 0z 0z FF	www: Pan Position zzzz: Tilt Position

Note:[X] in the above table indicates the camera address to be operated,[y]=[x + 8] .

1.2.2 Pelco-D protocol command list

SUM = sum of bytes, excluding the synchronization byte(The first byte 0xFF).

Function	Byte1	Byte2	Byte3	Byte4	Byte5	Byte6	Byte7
Up	0xFF	Address	0x00	0x08	Pan Speed	Tilt Speed	SUM
Down	0xFF	Address	0x00	0x10	Pan Speed	Tilt Speed	SUM
Left	0xFF	Address	0x00	0x04	Pan Speed	Tilt Speed	SUM
Right	0xFF	Address	0x00	0x02	Pan Speed	Tilt Speed	SUM
Upleft	0xFF	Address	0x00	0x0C	Pan Speed	Tilt Speed	SUM
Upright	0xFF	Address	0x00	0x0A	Pan Speed	Tilt Speed	SUM
DownLeft	0xFF	Address	0x00	0x14	Pan Speed	Tilt Speed	SUM
DownRight	0xFF	Address	0x00	0x12	Pan Speed	Tilt Speed	SUM
Zoom In	0xFF	Address	0x00	0x20	0x00	0x00	SUM
Zoom Out	0xFF	Address	0x00	0x40	0x00	0x00	SUM
Focus Far	0xFF	Address	0x00	0x80	0x00	0x00	SUM
Focus Near	0xFF	Address	0x01	0x00	0x00	0x00	SUM
Set Preset	0xFF	Address	0x00	0x03	0x00	Preset ID	SUM
Clear Preset	0xFF	Address	0x00	0x05	0x00	Preset ID	SUM
Call Preset	0xFF	Address	0x00	0x07	0x00	Preset ID	SUM
Query Pan Position	0xFF	Address	0x00	0x51	0x00	0x00	SUM
Query Pan Position Response	0xFF	Address	0x00	0x59	Value High Byte	Value Low Byte	SUM
Query Tilt Position	0xFF	Address	0x00	0x53	0x00	0x00	SUM
Query Tilt Position Response	0xFF	Address	0x00	0x5B	Value High Byte	Value Low Byte	SUM
Query Zoom Position	0xFF	Address	0x00	0x55	0x00	0x00	SUM
Query Zoom Position Response	0xFF	Address	0x00	0x5D	Value High Byte	Value Low Byte	SUM

1.2.3 Pelco-P protocol command list

Function	Byte1	Byte2	Byte3	Byte4	Byte5	Byte6	Byte7	Byte8
Up	0xA0	Address	0x00	0x08	Pan Speed	Tilt Speed	0xAF	XOR
Down	0xA0	Address	0x00	0x10	Pan Speed	Tilt Speed	0xAF	XOR
Left	0xA0	Address	0x00	0x04	Pan Speed	Tilt Speed	0xAF	XOR
Right	0xA0	Address	0x00	0x02	Pan Speed	Tilt Speed	0xAF	XOR
Upleft	0xA0	Address	0x00	0x0C	Pan Speed	Tilt Speed	0xAF	XOR
Upright	0xA0	Address	0x00	0x0A	Pan Speed	Tilt Speed	0xAF	XOR
DownLeft	0xA0	Address	0x00	0x14	Pan Speed	Tilt Speed	0xAF	XOR
DownRight	0xA0	Address	0x00	0x12	Pan Speed	Tilt Speed	0xAF	XOR
Zoom In	0xA0	Address	0x00	0x20	0x00	0x00	0xAF	XOR
Zoom Out	0xA0	Address	0x00	0x40	0x00	0x00	0xAF	XOR
Focus Far	0xA0	Address	0x01	0x00	0x00	0x00	0xAF	XOR
Focus Near	0xA0	Address	0x02	0x00	0x00	0x00	0xAF	XOR
Set Preset	0xA0	Address	0x00	0x03	0x00	Preset ID	0xAF	XOR
Clear Preset	0xA0	Address	0x00	0x05	0x00	Preset ID	0xAF	XOR
Call Preset	0xA0	Address	0x00	0x07	0x00	Preset ID	0xAF	XOR
Query Pan Position	0xA0	Address	0x00	0x51	0x00	0x00	0xAF	XOR
Query Pan Position Response	0xA0	Address	0x00	0x59	Value High Byte	Value Low Byte	0xAF	XOR
Query Tilt Position	0xA0	Address	0x00	0x53	0x00	0x00	0xAF	XOR
Query Tilt Position Response	0xA0	Address	0x00	0x5B	Value High Byte	Value Low Byte	0xAF	XOR
Query Zoom Position	0xA0	Address	0x00	0x55	0x00	0x00	0xAF	XOR
Query Zoom Position Response	0xA0	Address	0x00	0x5D	Value High Byte	Value Low Byte	0xAF	XOR

Chapter 2. Remote Controller

2.1 Keys Instruction

Finishing initialization, it can receive and execute the IR commands. Press the remote controller button, the indicator light is flashing; release the button, the indicator light stops flashing. Users can control the pan/tilt/zoom, setting and running preset positions via the IR remote controller.

In this instruction, "press the key" means a click rather than a long-press, and a special note will be given if a long-press for more than one second is required.

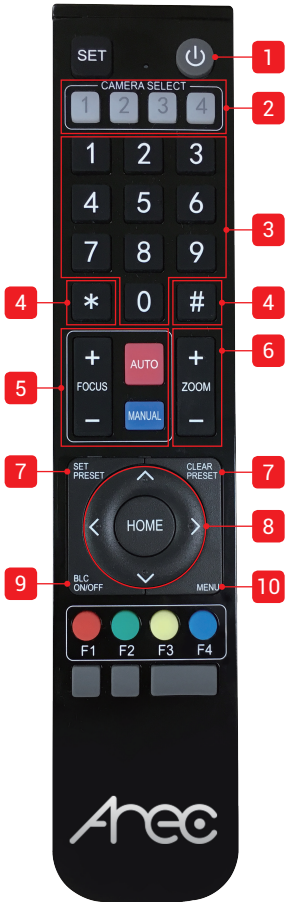

1. Standby Key	After 3S long press, the camera will step into standby mode. Long press 3S again, the camera will self-test again and back to HOME position. (Note: If power-on mode is turned on and Preset 0 is set, and there is no operation within 12s, it will automatically point to the specified preset position.
2. Camera Address Selection	Select the camera address which wants to be controlled
3. Number Key	Set or run 0-9 presets
4. *,# Key	Key combination use
5. Focus Control Key	Auto Focus: Enter into auto focus mode. Manual Focus: The camera focus mode is manual Switch the camera focus mode to manual focus by pressing [focus +] or [focus -] to adjust. Press and hold the key, the action of focus will keep continue and stops as soon as the key is released.
6. Zoom Control Key	Zoom+:Lens near / Zoom -:Lens far Press and hold the key, the camera will keep zooming in or zooming out and stops as soon as the key is released.
7. Set or Clear Preset key	Set Preset: Set preset key + 0-9 number key; Clear Preset key: Clear preset key + 0-9 number key
8. Pan/Tilt Control Key	Press Key :Up / Press Key :Down / Press Key :Left / Press Key: Right "HOME" Key: Return to the middle position or enter into the next level menu Press and hold the up/down/left/right key, the pan/tilt will keep running, from slow to fast, until it runs to the endpoint; the pan/tilt running stops as soon as the key is released.
9. BLC Control Key	BLC ON / OFF: Turn on or off the back light
10. Menu Setting	Open or close the OSD menu Enter / exit the OSD menu or return to the previous menu.

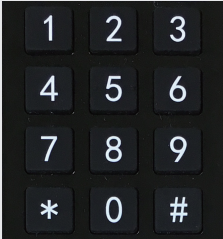
Name (press the key)	Brief instruction
	<ol style="list-style-type: none"> 1. Preset setting: to set a preset position, the users should press the "[SET PRESET]" key first and then press the number key 0-9 to set a relative preset, Note: 10 preset positions in total are available by remote controller. 2. Preset Running: Press a number key 0-9 directly to run a relative preset. Note: Action in vain if a relative preset position is not existed. 3. Preset clearing : to clear a preset position, the user can press the "[CLEAR PRESET]" key first and then press the number key 0-9 to clear the relative preset; Note : press the "[#]" key three times continually to cancel all the presets.

When a key-combination is required, do it in sequence. For example, "[*]+[#]+[F1]"means press "[*]"first and then press "[#]" and last press "[F1]".

Camera IR Remote Control Address Setting	
[*] + [#] + [F1]	Camera Address No.1
[*] + [#] + [F2]	Camera Address No. 2
[*] + [#] + [F3]	Camera Address No. 3
[*] + [#] + [F4]	Camera Address No. 4

Key Combination Functions	
[#] + [#] + [#]	Clear all presets
[*] + [#] + [6]	Restore factory defaults
[*] + [#] + [9]	Flip switch
[*] + [#] + Auto	Enter into the aging mode
[*] + [#] + [3]	Menu set to Chinese
[*] + [#] + [4]	Menu set to English
[*] + [#] + Manual	Restore the default user name, password, and IP address
[#] + [#] + [0]	Switch the video format to 1080P60
[#] + [#] + [1]	Switch the video format to 1080P50
[#] + [#] + [2]	Switch the video format to 1080I60
[#] + [#] + [3]	Switch the video format to 1080I50
[#] + [#] + [4]	Switch the video format to 720P60
[#] + [#] + [5]	Switch the video format to 720P50
[#] + [#] + [6]	Switch the video format to 1080P30
[#] + [#] + [7]	Switch the video format to 1080P25
[#] + [#] + [8]	Switch the video format to 720P30
[#] + [#] + [9]	Switch the video format to 720P25

2.2 Menu Setting

2.2.1 Main Menu

In normal working mode, press [MENU] key to display the menu, using scroll arrow to point at or highlight the selected items.

MENU ===== Language English (Setup) (Camera) (P/T/Z) (Video Format) (Version) (Restore Default) [↑ ↓] Select [← →] Change Value [Menu] Back [Home] OK	LANGUAGE: Language setting, Chinese / English SETUP: System setting CAMERA OPTION: Camera setting PTZ OPTION: Pan tilt setting VERSION: camera version setting Restore Default: Reset setting [↑ ↓] Select: for selecting menu [← →] Change Value: for modify parameters [MENU] Back: Press [MENU] to return [Home] OK: Press [Home] to confirm
--	--

2.2.2 System Setting

Move the pointer to the (Setup) in the Main Menu, click the [HOME] key and enter into the (System Setting) as shown below,

SETUP ===== Protocol Auto Visca Address 1 Visca Address Fix OFF PELCO-P Address 1 PELCO-D Address 1 Baudrate 9600 [↑ ↓] Select [← →] Change Value [Menu] Back	PROTOCOL: VISCA/Pelco-P/Pelco-D/Auto Visca ADDR: VISCA=1~7 Pelco-P=1~255 Pelco-D = 1~255 Baud rate: 2400/4800/9600/115200 Visca Address Fix: On/Off
---	--

2.2.3 Camera Setting

Move the pointer to the (CAMERA) in the Main Menu, click the HOME key and enter the (CAMERA) as follow,

CAMERA ===== (Exposure) (Color) (Image) (Focus) (Noise Reduction) Style Default [↑ ↓] Select [← →] Change Value Back ok	EXPOSURE: Enter into Exposure setting COLOR: Enter into color setting Image: Enter into image setting Focus: Enter into focus setting Noise Reduction: Enter into noise reduction
---	---

(1) EXPOSURE SETTING

Move the pointer to the (EXPOSURE) in the Main Menu, click the [HOME] and enter the (EXPOSURE SET) as follow,

<p>EXPOSURE =====</p> <p>Mode Auto EV OFF BLC OFF Flicker 50Hz G.Limit 4 DRC 4 [↑ ↓] Select [← →] Change Value [Menu] Back</p>	<p>Mode : Auto, Manual, Shutter priority, Iris priority and Brightness priority. EV : On/Off (only available in auto mode) Compensation Level: -7~7 (only available in auto mode when EV is ON) BLC: ON/OFF for options (only available in auto mode) Anti-Flicker: OFF/50Hz/60Hz for options (only available in Auto/Iris priority/Brightness priority modes) Gain Limit: 0~15(only available in Auto/ Iris priority /Brightness priority mode) WDR: Off,1~8 Shutter Priority:1/25,1/30,1/50,1/60,1/90,1/100,1/120,1/180,1/250,1/350,1/500,1/1000,1/2000,1/3000,1/4000,1/6000,1/10000(only available in Manual and Shutter priority mode) IRIS Priority:OFF,F11.0,F9.6,F8.0,F6.8,F5.6,F4.8,F4.0,F3.4,F2.8,F2.4,F2.0,F1.8(only available in Manual and Iris priority mode) Brightness: 0~23 (only available in Brightness priority mode)</p>
---	--

(2) COLOR SETTING

Move the pointer to the (COLOR) in the Main Menu, click the [HOME] and enter the (COLOR SET) as follow,

<p>COLOR =====</p> <p>WB Mode Auto RG Tuning 0 BG Tuning 0 Saturation 100% Hue 7 AWB Sensitivity High [↑ ↓] Select [← →] Change Value [Menu] Back</p>	<p>WB Mode:Auto,3000K,3500K,4000K,4500K,5000K,5500K,6000K,6500K,7000K,Manual,One Push RG Tuning:-10~10(only available in Manual mode) BG Tuning:-10~10(only available in Manual mode) Red Gain: 0~255(only available in Manual mode) Blue Gain: 0~255(only available in Manual mode) Saturation: 60%,70%,80%,90%,100%,110%,120%,130%,140%,150%,160%,170%,180%,190%,200% Hue: 0~14 AWB Sensitivity: high/middle/low</p>
--	--

(3) IMAGE

Move the pointer to the (IMAGE) in the Menu, click the [HOME] and enter the (IMAGE) as follow,

IMAGE		
=====		
Brightness	7	Brightness: 0~14
Contrast	7	Contrast: 0~14
Sharpness	6	Sharpness: 0~15
Flip-H	OFF	Flip-H: On/Off
Flip-V	OFF	Flip-V: On/Off
B&W-Mode	Color	B&W Mode: color, black/white
Gamma	Default	Gamma: default, 0.45, 0.50, 0.55, 0.63
DZoom	OFF	DZoom: digital zoom options: On/Off
DCI	Close	DCI: Dynamic Contrast: Off, 1~ 8
[↑ ↓] Select	[← →] Change Value	
[Menu] Back		

(4) FOCUS

Move the pointer to the (FOCUS) in the Menu, click the [HOME] and enter the (FOCUS) as follow,

FOCUS		
=====		
Focus Mode	Auto	Focus Mode: Auto, manual, one-push
AF-Zone	Center	AF-Zone: Up, middle, down, overall
AF-Sensitivity	Low	AF-Sensitivity: High, middle, low
[↑ ↓] Select	[← →] Change Value	
[Menu] Back		

(5) NOISE REDUCTION

Move the pointer to the (NOISE REDUCTION) in the Menu, click the [HOME] and enter the (NOISE REDUCTION) as follow,

NOISE REDUCTION		
=====		
NR-2D	3	2D Noise Reduction: Auto, close, 1~7
NR-3D	3	3D Noise Reduction: Close, 1~8
Dynamic Hot Pixel	OFF	Dynamic Hot Pixel: Close, 1~5
[↑ ↓] Select	[← →] Change Value	
[Menu] Back		

2.2.4 P/T/Z

Move the pointer to the (P/T/Z) in the Main Menu, click the [HOME] and enter the (P/T/Z) as follow,

<p>P/T/Z =====</p> <p>Speed by Zoom ON</p> <p>Zoom speed 8</p> <p>Image Freezing OFF</p> <p>Acc Curve Slow</p> <p>[↑ ↓] Select [← →] Change Value</p>	<p>Speed by Zoom: Only effective for remote controller, On/ Off; When zoom in, the PT control speed by remoter will become slow),</p> <p>Zoom Speed: Set the zoom speed for remote controller,1~8</p> <p>Image Freezing: On/Off</p> <p>Accelerating Curve: Fast/slow</p>
--	--

2.2.5 Video Format

Move the pointer to the (Video Format) in the Menu, click the [HOME] and enter the (Video Format) as follow,

<p>VIDEO FORMAT =====</p> <p>1080P60 1080P50</p> <p>1080I60 1080I50</p> <p>1080P30 1080P25</p> <p>720P60 720P50</p> <p>720P30 720P25</p> <p>1080P59.94 1080I59.94</p> <p>1080P29.97 720P59.94</p> <p>720P29.97</p> <p>[↑ ↓] Select [Menu] Back</p> <p>[Home] OK</p>	<p>Note:</p> <ol style="list-style-type: none"> 1. S: 1080P60 Downward Compatibility; M: 1080P30 Downward Compatibility 2. Exit menu after modifying parameter to save it after powered off
---	--

2.2.6 Version

Move the pointer to the (VERSION) in the Main Menu, click the [HOME] and enter the (VERSION) as follow,

<p>VERSION =====</p> <p>MCU Version 2.0.0.15 2015-12-18</p> <p>Camera Version 2.0.0.13 2015-12-18</p> <p>AF Version 2.0.0.6 2015-12-11</p> <p>Lens 12X(20X)</p> <p>[Menu] Back</p>	<p>MCU Version: Display MCU version information</p> <p>Camera Version: Display camera version information</p> <p>AF Version: Display the focus version information</p> <p>Lens: Display the lens zoom</p>
---	---

2.2.7 Restore Default

Move the pointer to the (RESTORE DEFAULT) in the Main Menu, click the [HOME] and enter the (RESTORE DEFAULT) as follow,

<pre> RESTORE DEFAULT ===== Restore Default? NO [↑↓] Select [←→] Change Value [Menu] Back [Home] OK </pre>	<p>Restore default: options: yes/no; after restoring default, the video format won't be restored.</p> <p>Note: If the address of former remoter is not 1 but another one from 2,3,4,the corresponding camera address will restore to 1 when all parameters or system parameters are restored. User should change the remoter address to be 1 (press No.1 according to the camera so to get normal operation)</p>
---	---

Chapter 3. Network Connection

You can connect your camera to a PC or notebook with standard network cable and enter the management site via your Internet browser or connect your camera to a router or any DHCP server. See below for details.



3.1 Direct connection

To access the camera for the first time, connect the camera and computer by network connecting cable. The computer must have the network segment where the camera IP address belong to. The device will not be accessible if without the segment. I.E. The camera default IP address is 192.168.11.202, then segment 11 must be added in the computer. Specific steps are as below :

- (a) Click "Open Network and Sharing Center".

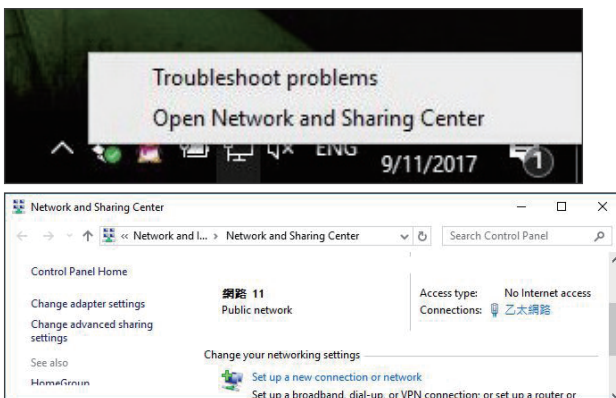

(b) Click the Properties button in Local Area Connection window and click the Internet Protocol Configuration (TCP/IPv4) option.

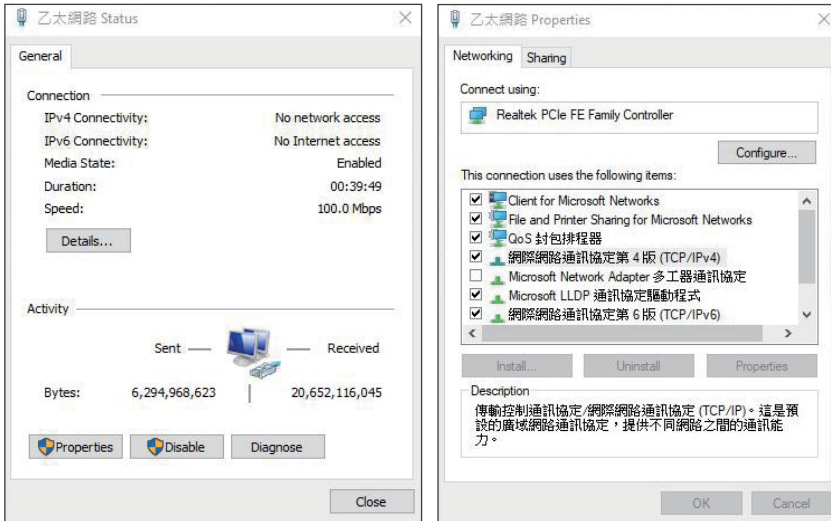

(c) Type IP : 192.168.11.1XX in "Use the following IP address:" field (Figure 1). Enter the static IP address of your CI-22H : 192.168.11.202 in your browser's URL bar (Figure 2). The management login page displays. (Enter account ID and password admin/admin for the first time.)

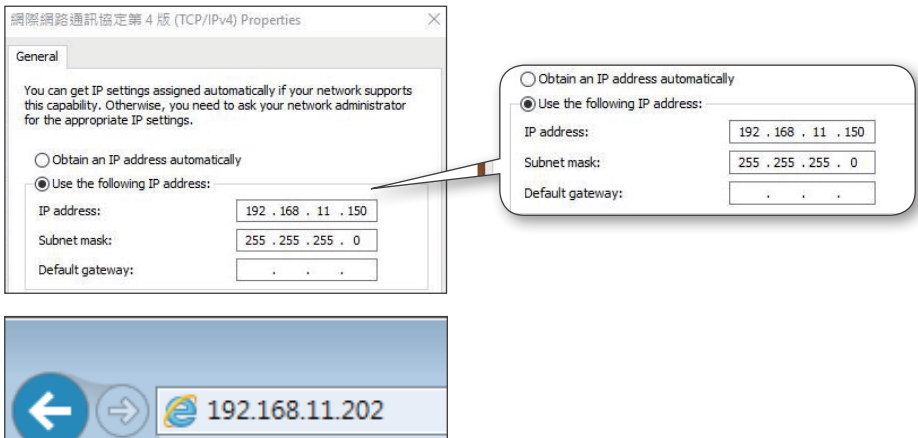



3.2 Internet connection mode

IP is assigned by a router or any DHCP server. To log in to the administration web, please connect the CI-22H and your PC / Notebook to a router or a DHCP server. Follow below steps:

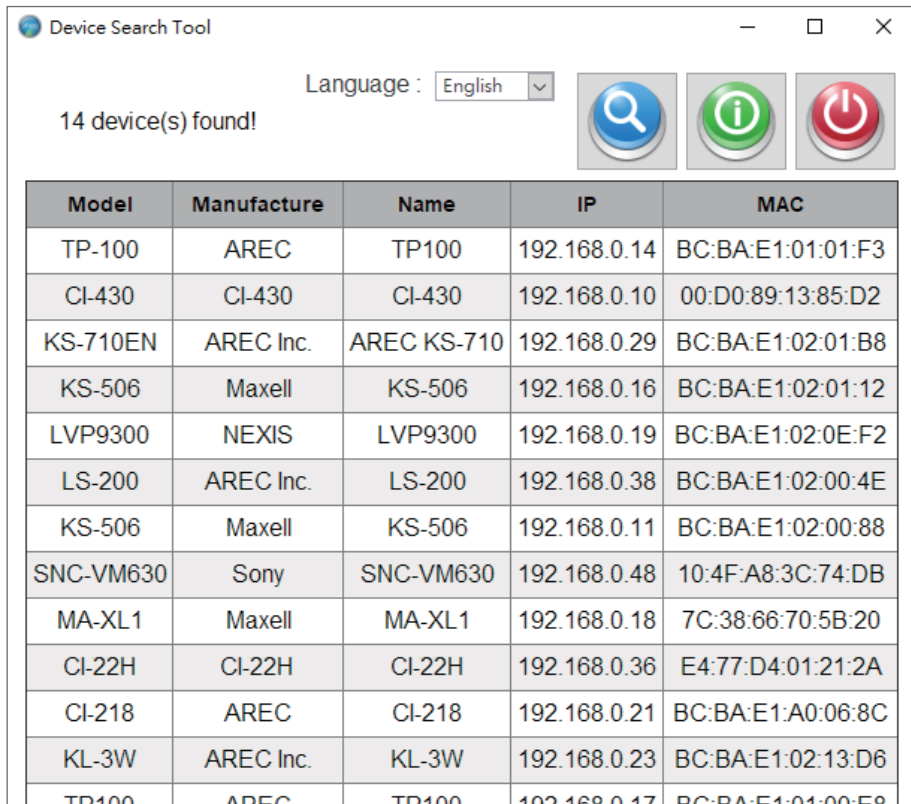
- Run the "Device Search Tool" utility, and click [] button.
- The tool should find the CI-22H and show detailed information. Double click on the founded camera.
- An access window will pop-up and ask for user name and password.(Enter account ID and password admin/admin for the first time.)



Device Search Tool

Language :   

14 device(s) found!

Model	Manufacture	Name	IP	MAC
TP-100	AREC	TP100	192.168.0.14	BC:BA:E1:01:01:F3
CI-430	CI-430	CI-430	192.168.0.10	00:D0:89:13:85:D2
KS-710EN	AREC Inc.	AREC KS-710	192.168.0.29	BC:BA:E1:02:01:B8
KS-506	Maxell	KS-506	192.168.0.16	BC:BA:E1:02:01:12
LVP9300	NEXIS	LVP9300	192.168.0.19	BC:BA:E1:02:0E:F2
LS-200	AREC Inc.	LS-200	192.168.0.38	BC:BA:E1:02:00:4E
KS-506	Maxell	KS-506	192.168.0.11	BC:BA:E1:02:00:88
SNC-VM630	Sony	SNC-VM630	192.168.0.48	10:4F:A8:3C:74:DB
MA-XL1	Maxell	MA-XL1	192.168.0.18	7C:38:66:70:5B:20
CI-22H	CI-22H	CI-22H	192.168.0.36	E4:77:D4:01:21:2A
CI-218	AREC	CI-218	192.168.0.21	BC:BA:E1:A0:06:8C
KL-3W	AREC Inc.	KL-3W	192.168.0.23	BC:BA:E1:02:13:D6
TP100	AREC	TP100	192.168.0.17	BC:BA:E1:01:00:E8

Note: To log in to the administration web by DHCP, please follow the Direct Connection mode to log in first and make the relevant settings. See "4.3.4 Network configure" for more details.

Note: Please do not put the power and network cable in places where can be easily touched to prevent video quality lowered by unstable signal transmission due to poor contact of cables.

Chapter 4. Overview of the Web Interface

Web client: Input the IP address 192.168.11.202 of the device in the address field of browser and click Enter button to enter into Web Client login page.

Note: Web access supported browsers: IE, 360 browser and other regular browser.



Download / Install Plug in : When first using IE browser to access the web conferencing camera, the login page will appear "Playback plug-in is not installed, please download and install!". Click on this message, download and install "MRWebXinstall.exe", according to information prompts.

Language selection : In login interface, the upper right corner shows "Chinese | English", click to select the web interface language.



Input the username and password after plug in installed. You can choose to log in as administrator or login in as normal user:

(1) Login in as administrator:

The default user name and password are both "admin".

After log in successfully, enter Administrator webpages. Users can enter preview, playback, configuration and logout pages.

(2) Login in as normal user:

The default user name and password are both "user1" or "user2".

After log in successfully, enter Administrator webpages. Users can enter preview, playback and logout pages.

Note: Normal user does not have permission to configuration page.

Menu	Description
Preview	Can control PTZ cameras, zoom, focus, snapshot, fullscreen, local recording, preset settings, etc.
Playback	Can playback the video and picture files that are stored in local PC.
Configuration	Including Local configuration, video configuration, network configuration, system configuration, and so on. Note: The normal user login does not have configuration rights.
Logout	Log out of the management interface.

4.1 Preview

After log in successfully, enter Administrator webpages. By default, the page shows Preview interface. The device facilitate the users control PTZ cameras, zoom, focus, snapshot, audio, fullscreen, local recording, SD card recording ,preset settings, etc.

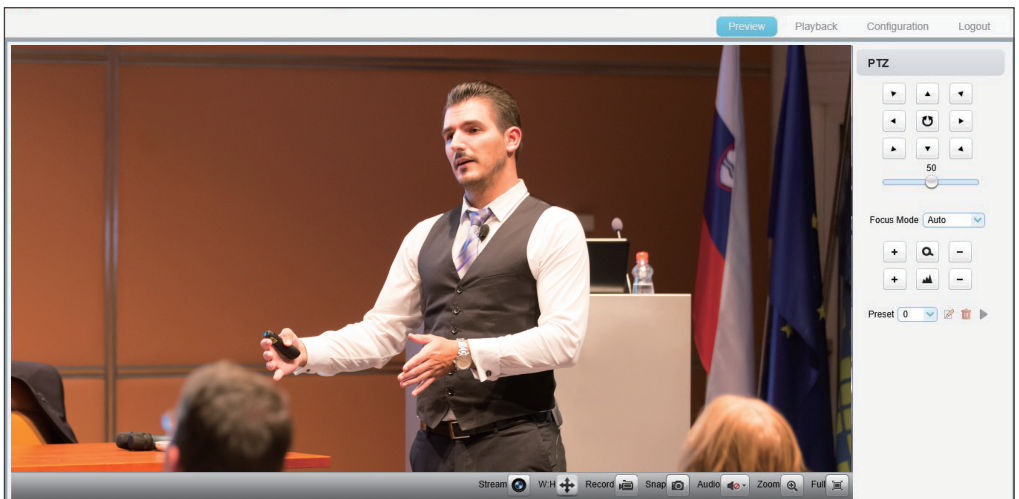

4.2 Playback

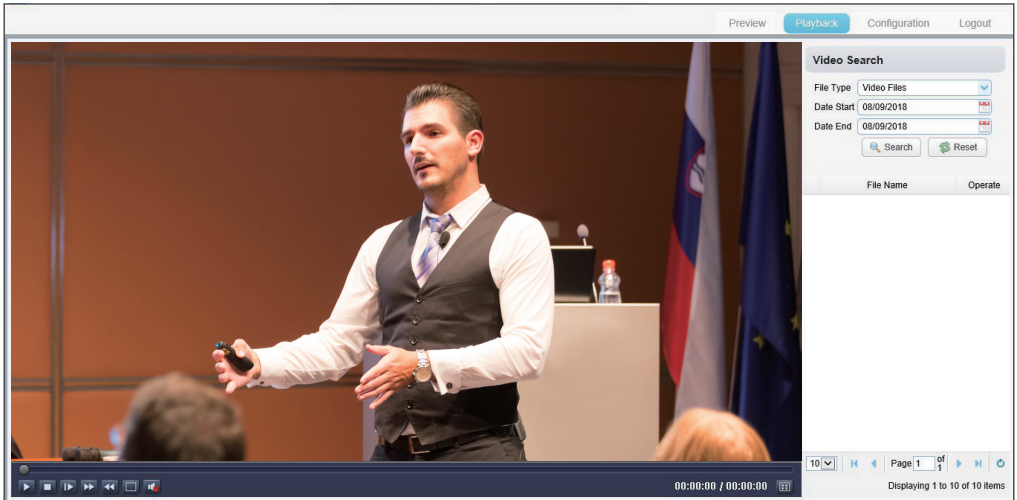

(1) Playback the recording file

Firstly record, snapshot and save the file when previewing. Click "Playback" to enter the page of video files and picture files playback.

- (a) Select "Video Files".
- (b) Set date range of the search, click the "search" to search for a recording file.
- (c) Click "Play" to playback the video file.

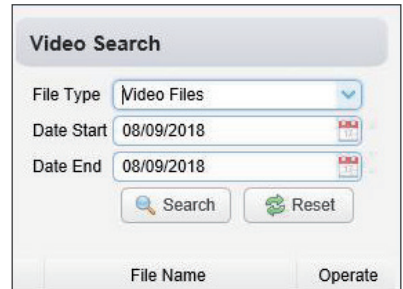

(2) Playback the picture file

Firstly record, snapshot and save the file when previewing. Click "Playback" to enter the page of recording file and picture file playback.

- (a) Select "Picture Files".
- (b) Set date range of the search, click the "search" to search for a recording file.
- (c) Click "Play" to playback the picture file.

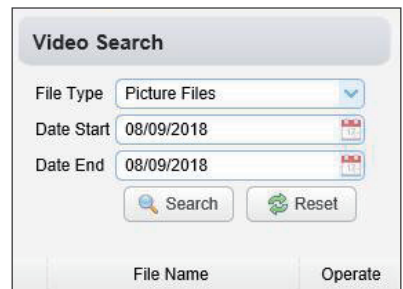

Local video / picture file default storage directory
D:\MyIPCam\

4.3 Configuration

Click Configuration to enter into the device parameters setting page.

Major options: Local configure, Audio configure, Video configure, Network configure and System configure.

The detailed description refer to below sheet.

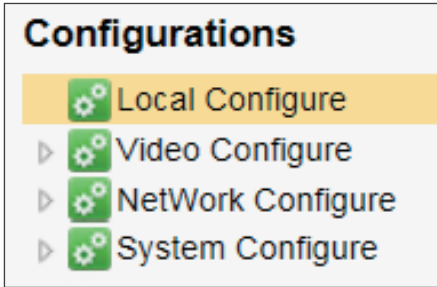

Menu	Explanation
Local configure	Including video stream preview mode, video packaging time, video file packaging type settings etc.
Video configure	Including video encoding, video parameters, character-overlapping, character size, video output setting etc.
Network configure	Including basic parameters, Ethernet, DNS, wireless network setting etc.
System configure	Including equipment property, system time, user management, version update, Reset, Reboot device settings etc.

4.3.1 Local configure

Preview Playback Configuration Logout

Configurations

- Local Configure
- Audio Configure
- Video Configure
- NetWork Configure
- System Configure

Local Configure

Video Stream Preview Mode: Real Time Generally(2)

Video Packaging Time(Minutes): 10

Video File Packaging Type: MP4

Videos/Pictures Storage Directory: D:\MyIPCam\

Save

Video Stream Preview Mode: User can choose real-time priority or fluency priority. The delay will be small when under real time priority mode and fluency will be good when under fluency priority mode. Setting based on the user need(Default value: real time normal (2). real time best (1), real time normal (2), fluency normal (3), fluency good (4) and fluency best (5) optional).

Video Packaging Time(Minutes): Set recording video packaging time (default is 10, range from 1~120 minutes).

Video File Packaging Type: Set recording video file packaging type(default MP4. TS, MP4 optional).

Videos/Pictures Storage Directory: Set videos/pictures storage directory(default D:\MyIPCam\).

Click the Save button to make settings effective.

4.3.2 Video configure

Major options: Video Encode, Stream Publish, RTP Multicast Video Parameters, Video OSD, OSD Font Size and Video Out. The detailed description refer to below sheet.

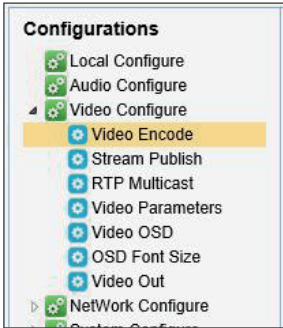

Set Option	Explanation
Video Encode	Set video output format of Main stream and Sub stream.
Stream Publish	Can turn on or off the Main / Sub stream and make the relevant settings.
RTP Multicast	Can turn on or off the RTP Multicast of Main / Sub stream and make the relevant settings.
Video Parameters	Adjust the focus, exposure, color, image, noise reduction, style and other parameters set.
Video OSD	Select whether to display the date and time, title, and adjust the font color and position.
OSD Font Size	Modify the Master / Slave stream font size.
Video Out	Select the video output format.

4.3.2.1 Video encode

Preview
Playback
Configuration
Logout

Configurations

- + Local Configure
- + Audio Configure
- + Video Configure
 - Video Encode
 - Stream Publish
 - RTP Multicast
 - Video Parameters
 - Video OSD
 - OSD Font Size
 - Video Out
- + NetWork Configure
- + System Configure

Video Encode

	Main Stream	Sub Stream
Compressed Format	H.264	H.264
Profile	HP	HP
Image Size	1920*1080	640*360
Rate Control	CBR	CBR
Image Quality	Best	Best
Bit Rate(Kb/S)	4096	800
Frame Rate(F/S)	30	30
I Frame Interval	75	75
I Frame Min QP	10	10
Stream Name	h264	h264_2

1. **Code stream:** It will call different code stream when setting different video output format. (Main stream and Sub stream)
2. **Compressed Format:** Set video compressing format and the device will reboot automatically. (Main/ Sub code stream default H.264, H.265 optional.)
3. **Profile:** Set H.264 / H.265 encode format and the device will reboot automatically. (H.264 encode format default HP, H.265 encode format default BP, BP, MP, HP optional).
4. **Image Size:** Set resolution, then device will restart automatically. (Main stream default 1920*1080, 1920*1080, 1280*720, 640*480 optional. Sub stream default 640*360, 640*360, 320*240, 640*480, 320*180, 1280*720 optional).
5. **Rate control:** Set rate control mode and the device will restart automatically. (Main / Sub stream default CBR, fixed rate is for option).

6. **Image quality:** Set image quality. (default for Main / Sub stream is best image, Best, better, good, bad, worse, worst for optional).
 7. **Bit Rate(Kb/S):** Set the video bit rate (Main stream default 4096 Kb/s, 64-40960 Kb/s optional; Sub stream default 800 Kb / s, 64-20480 Kb/s optional).
 8. **Frame Rate(F/S):** Set the video frame rate (Main / Sub stream default 30F/S, 5-30F/S optional).
 9. **I Frame Interval:** Set the key frame interval. (Main / Sub stream default 75F, 1-150F optional).
 10. **I Frame Min QP :** Set the key frame min QP. (Default 10, 10-51 optional.)
 11. **Stream Name:** User can revise the name of stream. (Main stream default h264, Sub stream default h264_2.)
- Click on the "Save" button to display the "Save successful" message, then set is to take effect

4.3.2.2 Stream publish

Preview Playback Configuration Logout

Configurations

- + Local Configure
- + Audio Configure
- + Video Configure
 - + Video Encode
 - + Stream Publish
 - + RTP Multicast
 - + Video Parameters
 - + Video OSD
 - + OSD Font Size
 - + Video Out
- + NetWork Configure
- + System Configure

Stream Publish

	Main Stream	Sub Stream
Enable	<input type="checkbox"/>	<input type="checkbox"/>
Protol Type	RTMP ▼	RTMP ▼
Host Address	<input type="text" value="192.168.5.11"/>	<input type="text" value="192.168.5.11"/>
Host Port	<input type="text" value="1935"/>	<input type="text" value="1935"/>
Stream Name	<input type="text" value="live/av0"/>	<input type="text" value="live/av1"/>
User Name	<input type="text"/>	<input type="text"/>
Password	<input type="text"/>	<input type="text"/>
Save		

1. **Switch:** To turn on or off the Main / Sub stream.
2. **Protocol Type:** Main / Sub stream are both use RTMP protocol.
3. **Host Address:** Server IP addresses
4. **Host Port:** Server port number (default 1935,0-65535 optional)
5. **Stream Name:** choose a different stream name (live/av0, live/av1 optional).
6. **User Name:** Set the user name.
7. **Password:** Set the password.

Click on the "Save" button to display the "Save successful" message, then set is to take effect.

39

4.3.2.3 Video parameters

Video Parameters page provide the settings of Focus, Exposure, Color, Image, NR and Style.

(a) Focus: The focus mode, focus range and focus sensitivity are configured here.

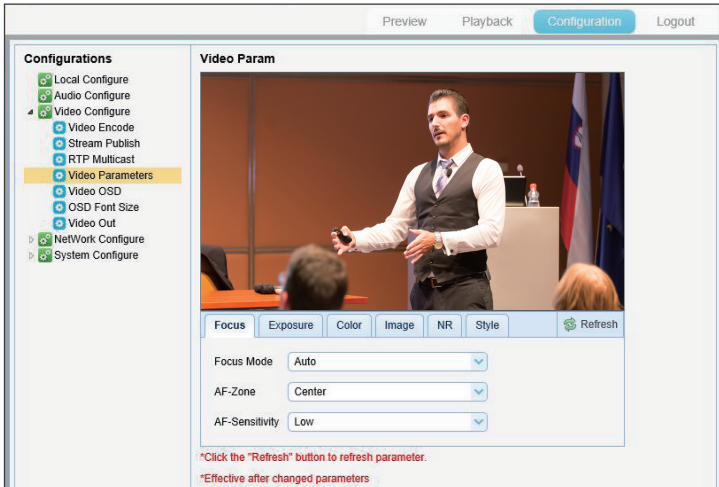

1. **Focus Mode:** Set the focus mode (the default auto, manual optional)
2. **AF-Zone:** set the focus range (the default center, top, bottom and all optional)
3. **AF-Sensitivity:** Set the focus sensitivity (default is low, high and middle optional)

(b) Exposure: This page include the following settings:

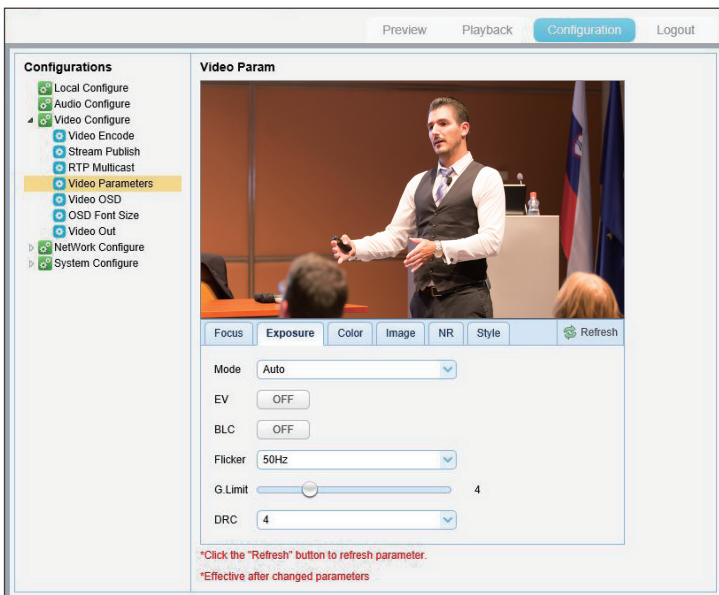

1. **Mode:** Set the exposure mode (the default automatic, manual, shutter priority, aperture priority, Brightness priority optional)
2. **EV:** Exposure compensation setting is active when it is auto status (default is off).
3. **EV Level:** Set the exposure compensation value, valid when it is set for auto(default 0, -7 to 7 optional).
4. **BLC:** Set back light compensation, valid when it is auto status (default is off).
5. **Flicker:** Set up anti-flicker mode, valid when status of automatic, aperture or brightness priority (default 50Hz, closed, 60Hz optional).
6. **G.Limit:** Set the gain limits, auto, active when it is status of aperture or brightness priority(default 4, 0-15 optional).
7. **DRC:** Set the dynamic range (default 4, Off, 1-8 optional).
8. **Shutter speed:** Active when it is status of manual or shutter-priority (default 1/100, 1/25, 1/30, 1/50, 1/60, 1/90, 1/100, 1/120, 1/180, 1/250, 1/350, 1/500, 1/1000, 1/2000, 1/3000, 1/4000, 1/6000, 1/10000 optional).
9. **Aperture value:** Set the aperture value, active when it is status of manual or aperture-priority(default F1.8, closed, F11.0, F9.6, F8.0, F6.8, F5.6, F4.8, F4.0, F3.4, F2.8, F2.4, F2.0, F1.8 optional).
10. **Brightness:** Set the brightness value, active when it is a state of brightness priority (default 11,0-23 optional).

(c) Color: This page include the following settings:

1. **WB Mode:** Set the white balance mode (the default automatic, 3000K, 3500K, 4000K, 4500K, 5000K, 5500K, 6000K, 6500K, 7000K, manual, Onepush optional).
Note: Click the "Adjust" button when selected the One-push white balance mode.
2. **RG Tuning:** Set red fine tuning, Only effective when white balance mode is manual (default 0, -10~10 optional).

3. **BG Tuning:** Set blue fine tuning, Only effective when white balance mode is manual (default 0, -10~10 optional)
4. **Saturation:** Set the saturation (default 100%, 60%, 70%, 80%, 90%, 100%, 110%, 120%, 130%, 140%, 150%, 160%, 170%, 180%, 190%, 200% optional).
5. **Hue:** Set the chroma (default 7,0-14 optional).
6. **AWB Sensitivity:** Sensitivity Auto white balance settings (default is high, medium, low optional).
7. **Red Gain:** Set Red Gain. Only effective when white balance mode is manual (default 84, 0~255 optional)
8. **Blue Gain:** Set Blue Gain. Only effective when white balance mode is manual (default 73, 0~255 optional)

(d) Image: This page include the following settings:

The screenshot shows the 'Configuration' tab of the CI-22H interface. On the left is a 'Configurations' sidebar with a tree view where 'Video Parameters' is selected. The main area is titled 'Video Param' and features a live video feed of a man in a vest speaking at a podium. Below the video feed are several tabs: 'Focus', 'Exposure', 'Color', 'Image', 'NR', and 'Style'. The 'Image' tab is active, displaying sliders for 'Bright' (set to 7), 'Contrast' (set to 7), and 'Sharpness' (set to 6). Below these are dropdown menus for 'Gamma' (set to 'Default') and 'DCI' (set to 'OFF'). There are also buttons for 'B&W Mode' (set to 'Color') and 'DZoom' (set to 'OFF'). A 'Refresh' button is located to the right of the 'Image' tab. At the bottom of the interface, there are two red text notes: '*Click the "Refresh" button to refresh parameter.' and '*Effective after changed parameters'.

1. **Bright:** Set the brightness (default 3, 0-14 optional).
2. **Contrast:** set the contrast (default 8, 0-14 optional).
3. **Sharpness:** Sets the sharpness value (default 6, 0-15 optional).
4. **Gamma:** Gamma value setting (default, 0.45, 0.50, 0.52, 0.55 optional).
5. **DCI:** Set the dynamic contrast (default Off, 1-8 optional).
6. **B&W Mode:** Set black and white mode (default color, B&W optional).
7. **DZoom:** digital zoom On/Off

(e) NR (Noise Reduction):

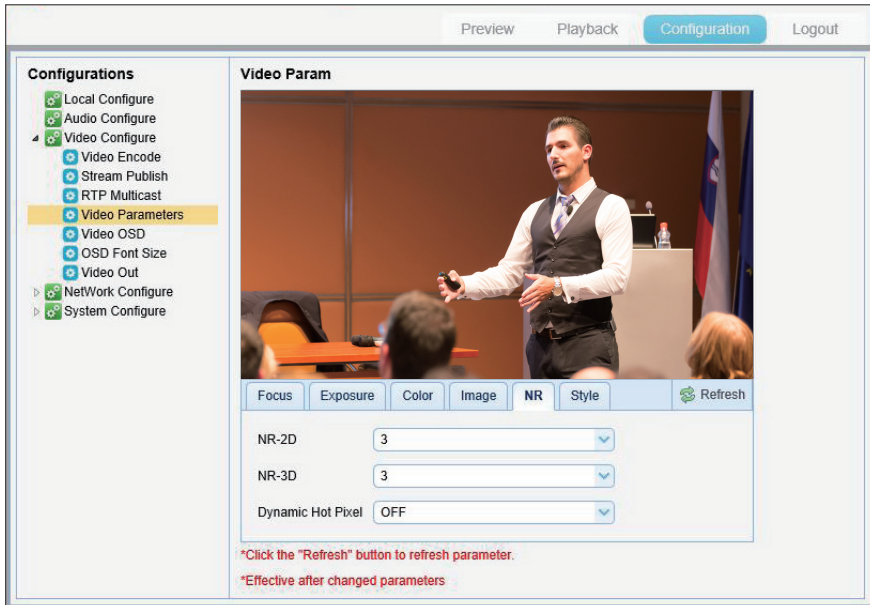

1. NR-2D: Set 2D noise reduction level (default 3, 1-7, Auto and Off optional).
2. NR-3D: Set 3D noise reduction level (default 5, 1-8 and Off optional).
3. Dynamic Hot Pixel: Set Dynamic dead pixel correction (default Off, 1-8 and Off optional).

(f) Style: Select display style (default, normal, Clarity, Bright, Soft optional).

Note: Click the "Refresh" to make revision of the a,b,c,d,e,f values become effective in the video.

4.3.2.4 Video OSD

1. **Show date and time:** Set whether to display the time and date (default show).
2. **Show Title:** Set whether to display the title (default show).
3. **Time font color:** Set the time and date font color (default white, black, yellow, red, blue optional).
4. **Title font color:** Set the title font color (default white, black, yellow, red, blue optional).
5. **Moving characters:** Set the date, time and title display position, click on the "up, down, left, right" buttons to move the corresponding character position.
6. **Title Content:** Set title content.
7. **Time Content:** Set time content (default 1970/01/10 05:36:00)

Click on the "Save" button and display the "Save successful" message, then set is to take effect.

4.3.2.5 OSD font size

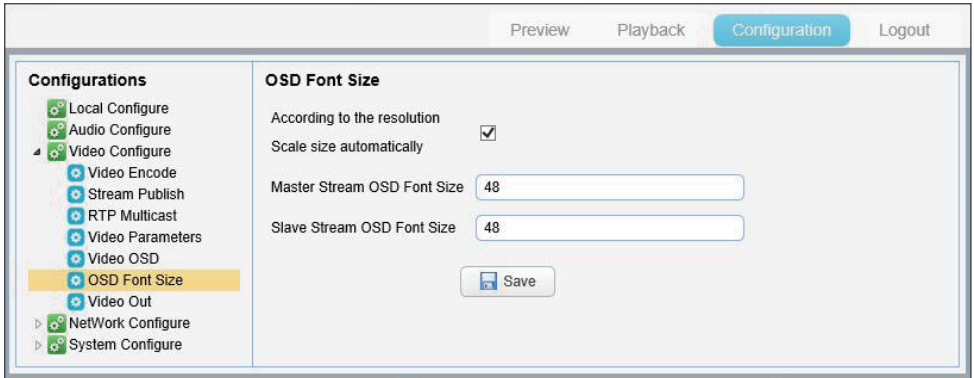

1. **Master Stream OSD Font Size:** Set the character size of the display, the device will restart automatically after changed and saved (default 48, 8-200 optional)
2. **Slave Stream OSD Font Size:** Set the character size of the display, the device will restart automatically after changed and saved (default 48, 8-200 optional)

Click on the "Save" button to display "Parameter saved successfully" message, set to take effect.

4.3.2.6 Video out

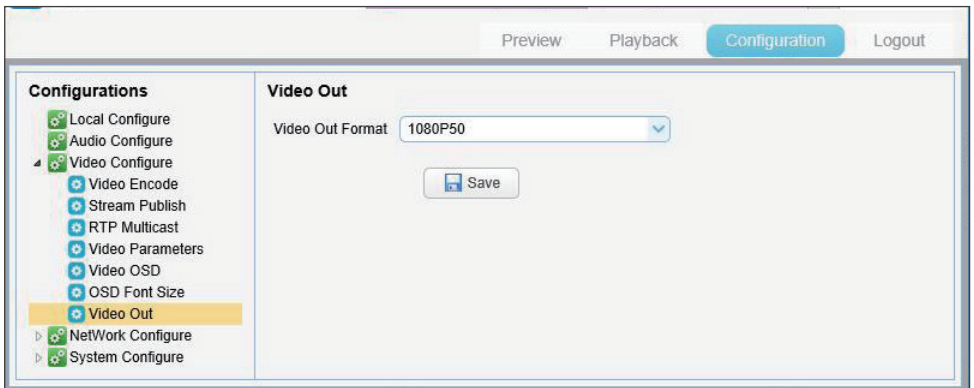

1. **Video Out Format:** Set the video output format (default 1080P50, 1080P25, 1080I60, 1080I50, 720P60, 720P50 optional).

Click on the "Save" button to display the "Save successful" message, then valid.

4.3.3 Network configure

Major options:. The detailed description refer to below sheet.



Set Option	Explanation
Network port	Set the network port, including data, web, onvif, etc.
Ethernet	Set whether to open to obtain IP automatically or set the ip address.
DNS	Set the DNS parameters.
GB28181	Enable GB28181, and related settings.

4.3.3.1 Network port

The screenshot shows the 'Configuration' tab of the Arec interface. On the left, a 'Configurations' sidebar lists various settings, with 'Network Port' selected and highlighted in yellow. The main area, titled 'Network Port', contains several input fields for port numbers:

- Port Data: 3000
- Port Web: 80
- Port Onvif: 2000
- Port Soap: 1936
- Port RTMP: 1935
- Port Rtsp: 554
- Port Visca: 1259

At the bottom of the configuration area is a 'Save' button with a floppy disk icon.

1. **Port Data:** Set the data port, the device will restart automatically after changed(default 3000, 0-65535 optional).
2. **Port Web:** Set Web port, the device will restart automatically after changed (default 80, 0-65535 optional).
3. **Port Onvif:** Set Onvif port, the device will restart automatically after changed(default 2000, 0-65535 optional).
4. **Port Soap:** Set Soap port (default 1936, 0-65535 optional).
5. **Port RTMP :** Set RTMP port (default 1935, 0-65535 optional).
6. **Port Rtsp:** Set RTSP port, the device will restart automatically after changed (default 554, 0-65535 optional).
7. **Port Visca:** Set Visca port, the device will restart automatically after changed (default 1259, 0-65535 optional).

Click "Save" button to display the "Save successful" message, then valid.

the way to get RTMP: rtmp://device IP address:1935/live/av0 (Main stream name:av0; Sub stream name: av1.)

the way to get RTSP: rtsp://device IP address:554/live/av0 (Main stream name:av0; Sub stream name: av1.)

4.3.3.2 Ethernet parameters

The screenshot shows a web-based configuration interface for an Arec device. At the top, there are four tabs: "Preview", "Playback", "Configuration" (which is active and highlighted in blue), and "Logout". On the left side, there is a "Configurations" sidebar with a tree view containing: "Local Configure", "Audio Configure", "Video Configure", "NetWork Configure" (expanded), "Network Port", "Ethernet" (highlighted in yellow), "DNS", "GB28181", and "System Configure". The main content area is titled "Ethernet" and contains the following settings:

- DHCP**: A checkbox that is currently unchecked.
- IP Address**: A text input field containing "192.168.11.202".
- Subnet Mask**: A text input field containing "255.255.255.0".
- Default Gateway**: A text input field containing "192.168.11.254".
- MAC Address**: A text input field containing "E4:77:D4:01:18:B8".

At the bottom of the Ethernet configuration area, there is a "Save" button with a floppy disk icon.

1. **DHCP** :Set whether to open to obtain IP automatically. The machine will restart automatically after change(off by default)

2. **IP Address**: Set the IP address, the device will restart automatically after changes (default 192.168.11.202).

Note: Here is the IP address of the web page of the sign-in address

3. **Subnet Mask**: Set the subnet mask (default 255.255.5.0).

4. **Default Gateway**: Set the default gateway (default 192.168.11.254).

5. **MAC Address**: Set the physical address (the parameter is read-only but can not be modified).

Click on the "Save" button to display the "Save successfully" message, then the set is to take effect (Note: To prevent IP conflicts when modify).

4.3.3.3 DNS

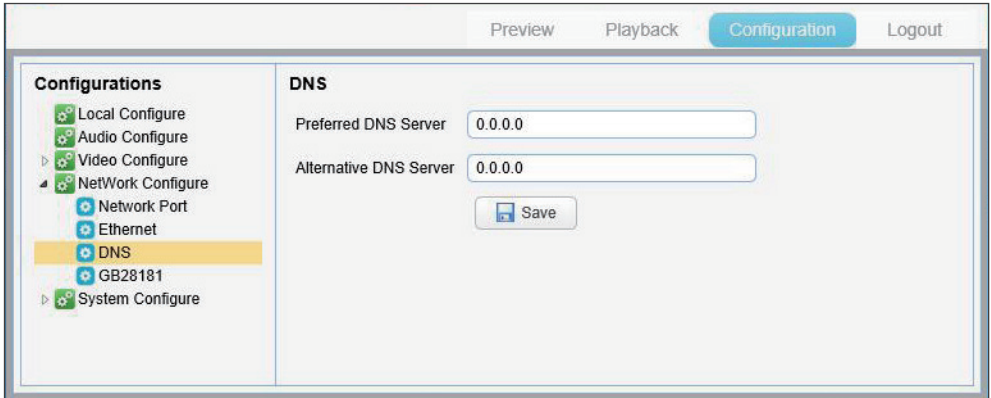

The screenshot shows a web-based configuration interface. At the top right, there are four buttons: "Preview", "Playback", "Configuration" (highlighted in blue), and "Logout". On the left side, there is a "Configurations" menu with a tree view. The items are: "Local Configure", "Audio Configure", "Video Configure", "NetWork Configure" (expanded), "Network Port", "Ethernet", "DNS" (highlighted in yellow), "GB28181", and "System Configure". The main area is titled "DNS" and contains two input fields: "Preferred DNS Server" and "Alternative DNS Server", both with the value "0.0.0.0". Below these fields is a "Save" button with a floppy disk icon.

1. **Preferred DNS Server** : Set the preferred DNS server. (Default 0.0.0.0).

2. **Alternative DNS Server** : Alternative DNS server settings. (Default 0.0.0.0).

Click on the "Save" button to display the "Save successfully" message, then the set is to take effect.

4.3.3.4 GB28181

Preview Playback Configuration Logout

Configurations

- + Local Configure
- + Audio Configure
- + Video Configure
- + NetWork Configure
 - + Network Port
 - + Ethernet
 - + DNS
 - + GB28181
 - + System Configure

GB28181

Enable

ClockSync

Video Type Main Stream

Registration Valid Time(s) 3600

Heartbeat Time(s) 60

Register ID 34020000001320000001

Register Name IPC

Register Password ••••••••

Equipment Belong

Administrative Region

Alarm Areas

Device Address

Local SIP Port 5060

Server IP

Server SIP Port 5060

Server ID 34020000002000000001

Save

1. **Enable:** Set whether open GB28181, can check.
2. **ClockSync:** Whether synchronization time is set, you can check
3. **Video Type:** Video stream type setting (the default main stream, secondary stream optional)
4. **Registration Valid Time(s):** 3600. Range 5-65535
5. **Heartbeat Time(s):** 60 Range 1-65535
6. **Register ID:** 34020000001320000001
7. **Register Name:** IPC
8. **Register Password:** 12345678
9. **Equipment Belong:** Users can add their own
10. **Administrative Region:** Users can add their own
11. **Alarm Areas:** Users can add their own
12. **Device Address:** Users can add their own
13. **Local SIP Port:** 5060 Range 0-65535
14. **Server IP :** IP address of the computer
15. **Server SIP Port:** 5060 Range 0-65535
16. **Server ID:** 34020000002000000001

Click on the "Save" button to display "Parameter saved successfully" message, set to take effect.

4.3.4 System configure

Major options: System Attribute, System Time, User Set, Release Upgrade, Restore factory defaults and Reboot. The detailed description refer to below sheet.

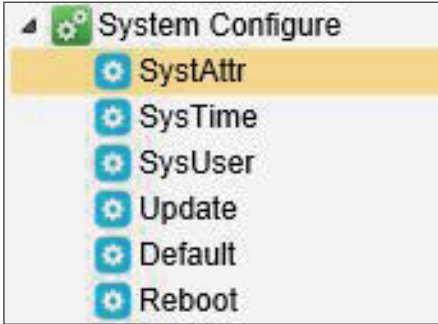

Set Option	Explanation
System Attribute	Set the device name, ID and change the system language.
System Time	Set the system date and time.
User Set	Set the user name and password.
Release Upgrade	Show camera and AF Version, you can update the version.
Restore factory defaults	Restore factory defaults.
Reboot	Reboot the device.

4.3.4.1 System attribute

The screenshot displays the configuration interface for the CI-22H device. At the top, there are four tabs: "Preview", "Playback", "Configuration" (which is active and highlighted in blue), and "Logout". On the left side, there is a "Configurations" menu with a tree view. The items listed are: Local Configure, Audio Configure, Video Configure, NetWork Configure, System Configure (expanded), SystAttr (highlighted in yellow), SysTime, SysUser, Update, Default, and Reboot. The main area on the right is titled "System Attribute" and contains three input fields: "Device Name" with the value "CI-22H", "Device ID" with the value "1", and "Language" with a dropdown menu set to "English". Below these fields is a "Save" button with a floppy disk icon.

1. **Device Name:** Set the device name (the default CI-22H, user can add their own).
 2. **Device ID:** Set the device ID (default 1, Read-Only).
 3. **Language:** Set the system language (default English, Simplified Chinese optional). Need to re-login after modify and save the setting.
- Click on the "Save" button to display the "Save the parameters successfully" message, then the set is to take effect.

4.3.4.2 System time

(a) System Time

- Date Format:** Set the date format (YYYY-MM-DD default That year - month - day, MM-DD-YYYY namely Month - Day - Year, DD-MM-YYYY date - month - year optional).
- Date Sprtr:** Set the date separator (default '/', ',', '-' optional).
- Zone:** Set the time zone (default East eight districts, other time zones optional).
- Hour Type:** Set the time types (default 24 hours, optional 12 hours).
- NTP Enable:** Set whether open NTP, can check.
- Update interval:** Set the NTP server automatic updated time interval.Valid after setting NTP server synchronization (default one day, 2-10 days Optional).
- Host Url:** Set NTP server address or domain name (default time.nist.gov). Valid after setting NTP server synchronization.
- Host Port:** Sets the NTP server port (default 123).Valid after setting NTP server synchronization.

Click on the "Save" button to display the "Save the parameters successfully" message, then the set is to take effect.

(b) Time Settings

1. **Time settings:** Set time mode (to choose the computer time synchronization, NTP server time synchronization, or set manually).
2. **Computer Time:** Set the computer synchronization valid.
3. **Set the time manually:** Click the calendar icon on the right to set the time manually. Effective when set manually.

Time Settings

Time Settings Set manually ▾

New Time 08/10/2017 09:54:01

Aug 2017

S	M	T	W	T	F	S
30	31	1	2	3	4	5
6	7	8	9	10	11	12
13	14	15	16	17	18	19
20	21	22	23	24	25	26
27	28	29	30	31	1	2

09:54:01 ▾

Today Ok Close

4.3.4.3 User set

Preview Playback Configuration Logout

Configurations

- Local Configure
- Audio Configure
- Video Configure
- NetWork Configure
- System Configure
 - SystAttr
 - SysTime
 - SysUser
 - Update
 - Default
 - Reboot

User Set

Authority: admin

User Name: admin

Password:

Confirm Password:

Save

1. **Authority** : Set the user type (the default administrator, User 1, User 2 optional)
2. **User name**: Set the user name (Select User Administrator default admin; select a user1 default user1; to select a user 2 default user2; user can modify their own)
3. **Password**: Set a password(Select User Administrator default admin; select a user1 default user1; to select a user 2 default user2; user can modify their own).
4. **Confirm Password**: Confirm the input passwords are the same or not.

Click on the "Save" button to display the "Save successfully" message, then the set is to take effect.

Note: Please note the case-sensitivity of the user name and password.

Note: If login page by a common user's name and password , one does not have configuration privileges but can only operate to preview, playback, logout.

4.3.4.4 Release upgrade

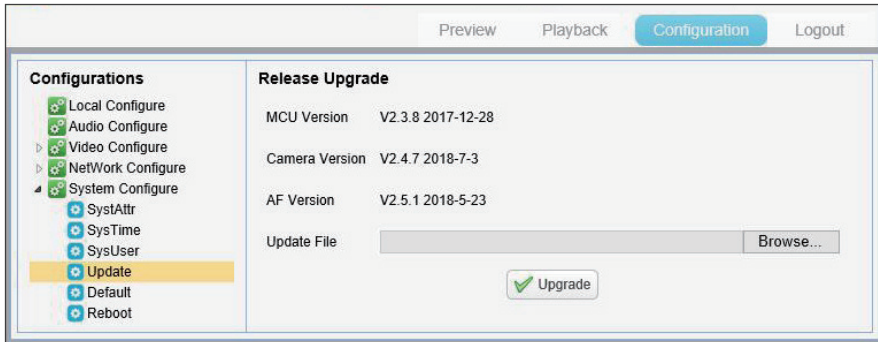

This page displays the device version. Users only read the version information above which is consistent with the menu version but can not modify. Different types of the machine has different information.

Update file: Click "Browse ..." installation, to select the upgrade file in the pop-up window. Click on the "Upgrade" button, the upgrade dialog will appear. the device will reboot automatically after update successfully.

Note: Make sure the power and network is keeping connected during the process, or the upgrade will fail.

4.3.4.5 Restore factory defaults

Restore factory defaults: Click on pop-up "Restore Factory Defaults" button and choose "yes" or "no", then the device will restart automatically and restore factory setting.

4.3.4.6 Reboot

Rebook the device: Click on the pop-up "Reboot" button and choose "yes" or "no", then the device will restart automatically.

4.4 Logout

Click "logout" and the logout dialog pop out. Click "yes" or "no" to choose to logout the present page and return to the user login page.

Chapter 5. Camera Maintenance and Troubleshooting

5.1 Camera Maintenance

- (1) If camera is not used for long time, please turn off power adapter switch and AC plug.
- (2) Use soft cloth or tissue to clean the camera cover.
- (3) Use soft cloth to clean the lens; Use neuter cleanser if bad smeared. No use strong or corrosive cleanser or corrosive cleanser avoiding scuffing.

5.2 Troubleshooting

- (1) No video output
 - (a) Check whether the camera power supply is connected, the voltage is normal, the power indicator is lit.
 - (b) Whether the machine could do self-inspection after restarted.
 - (c) Check whether the video output cable or video display is normal
- (2) No image sometimes
 - (a) Check whether the video output cable or video display is normal
- (3) Image dithering when zoom-in or zoom-out
 - (a) Check whether the camera installation position is solid
 - (b) Whether there is shaking machine or objects around the camera
- (4) Remote controller can not work
 - (a) Remote control address is set to 1 (if the machine is set back to the factory defaults, remote control addresses need to be back to 1 too)
 - (b) Check whether the battery is installed on the remote controller or low .
 - (c) Check the menu whether is closed, camera control through remote controller is only available after exiting the menu. If video output from LAN, menu will not be displayed, menu will automatically exists 30s later, then it can be controlled by remote controller.
- (5) Serial port can not work.
 - (a) Check whether the camera serial device protocol, baud rate, address is consistent
 - (b) Check whether the control cable is connected properly
- (6) Web pages cannot log in
 - (a) Check whether the camera is showing normally.
 - (b) Check whether the network cable is connected properly (Ethernet port yellow light flashes to indicate normal network cable connection)
 - (c) Check whether your computer is added the segment and the segment is consistent with the IP address of the camera
 - (d) Click "Start" and select "Run" and then type "cmd" in the computer; Click "OK" then turn on a DOS command window to enter ping 192.168.11.202. Press the Enter key to appear message as follows: Description network connection is normal

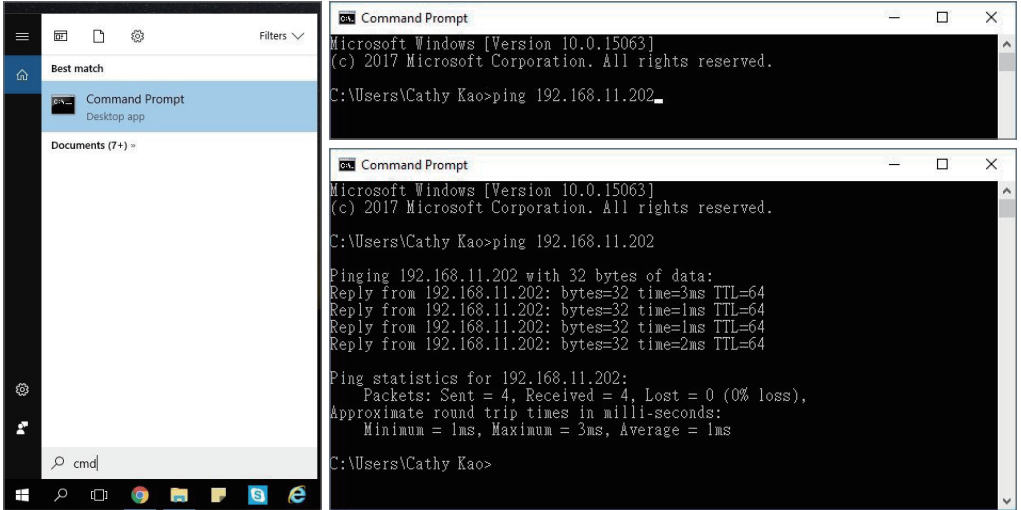



AREC Inc.© All Rights Reserved 2021. | www.arec.com
All information contained in this document is Proprietary



Made in Taiwan
Date : 2021.12.1
Version : 2.5.7 2019-12-12

AREC have the right to change or improve product specifications, without obligation to notify any user.
Go to www.arec.com get the latest information related to the product or additional information.